

NOW PART OF

XiVE®

DENTSPLY SIRONA

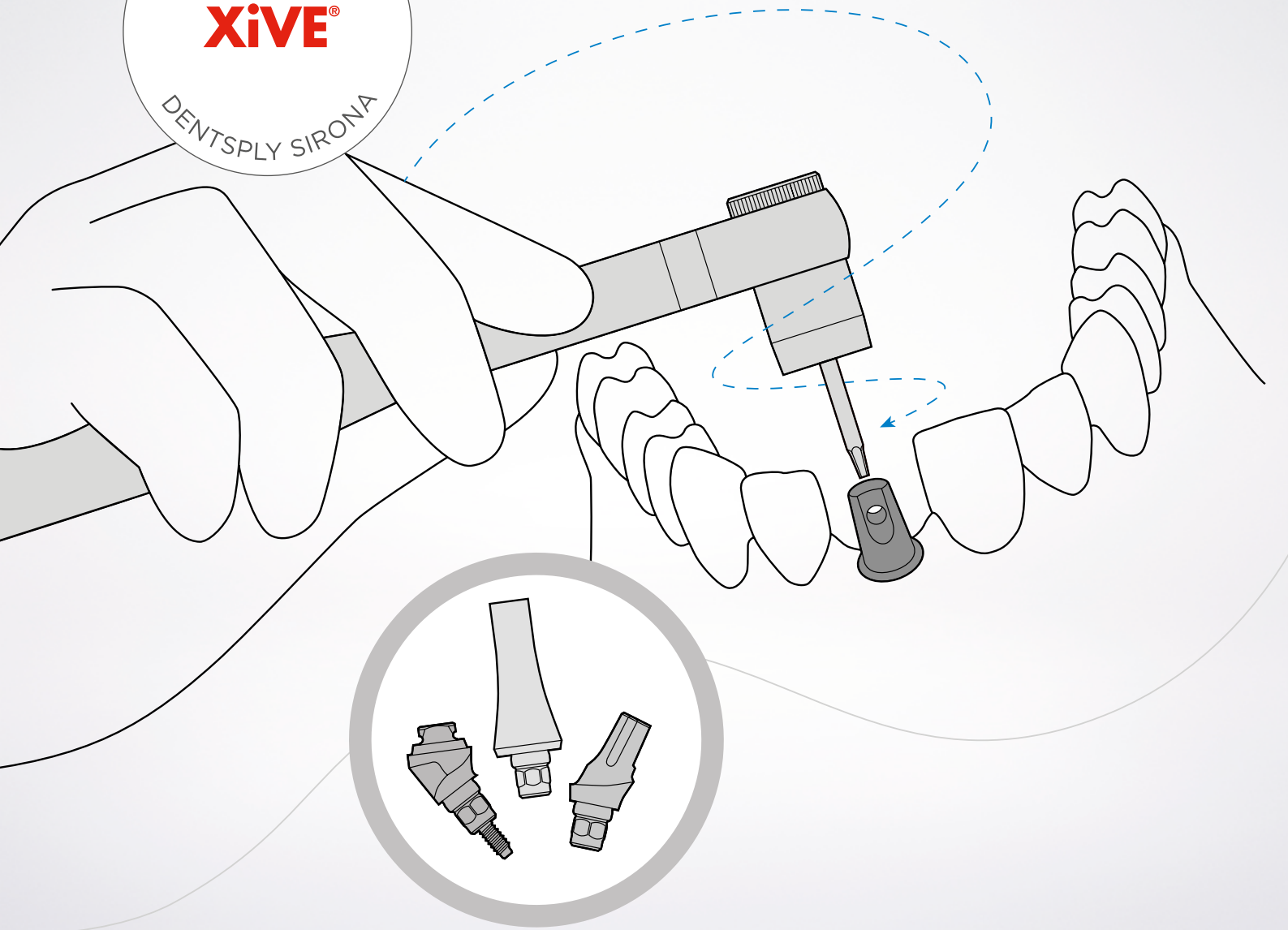

XiVE®

Prosthetic Manual



Smartness in practice

Xive provides flexibility, smartness and userfriendliness to dental professionals favoring the advantages of a hexagon interface connection.

The system was originally developed in a unique and pioneering collaboration between clinicians and industry. Experience met innovation with one common purpose - to develop an implant system that is as intuitive as it is efficient, delivering reliability and peace of mind to dental professionals and their patients worldwide.

CONTENTS

System concept	4
Treatment planning	8
Implant healing & exposure	
Implant healing	12
Implant exposure	14
Soft tissue management and temporary solutions	15
Xive® S prosthetics	
Basics of Friadent® / Xive® S prosthetics	24
Xive® S prosthetic navigator	27
Impression taking	34
Impression taking on implant level	36
Impression taking on abutment level	42
Restorations with Xive® S	
Single tooth crowns	46
Fixed solutions for larger tooth gaps and the edentulous jaw	66
Removable solutions for the edentulous jaw	86
Xive® TG prosthetics	
The basics of Xive TG prosthetics	106
Xive TG prosthetic navigator	108
Impression taking with Xive TG	110
Restorations on Xive TG implants	112

Please read this manual carefully before using the system for the first time and observe the directions and notes in the instructions for use of the system components and instruments at all times. We also recommend that all users attend a training course in the system before using a new implant system for the first time.

System concept

Comprehensive implant selection

Xive® implant diameters and lengths

Whether the narrowest gap or edentulous jaw, hard or soft bone, single or two stage, immediate or delayed loading, Xive helps you achieve outstanding and predictable results for every case. With a comprehensive range of implants from 3.0 mm up to 5.5 mm diameter, and 8 mm up to 18 mm length, the bone-specific preparation protocol and wide range of prosthetic options available with the system is appreciated by dental professionals around the world.

The wide range of implant diameters and lengths in combination with the cylindrical implant body optimizes the available bone volume – even in anatomically complex situations. In many cases additional grafting procedures are not necessary. In addition to the subgingival Xive S cylindrical screw implants, the Xive implant range also includes the option of transgingival Xive TG implants. The endosseous section of both types of implants is identical, which means that preparation for both implant types uses the same instruments. The selection of type of implant to use can then be decided during the surgical procedure.



Color coding

Each Xive implant diameter is identified by different color-coding, which can be found on all implant packages, instruments and prosthetic components. The color-coding makes it easy to identify the diameter and select the right prosthetic components.



Xive® implant-abutment connection

Xive® S: The deep, internal hexagon connection

The deep, internal hexagon Xive S implant-abutment connection locks the prosthetic components in the implant by transferring lateral forces directly from the internal geometry of the implant via the abutment.

Xive S implant-abutment connection permits

- Clear and accurate positioning of the abutment due to six positioning options
- Rotation lock due to internal hexagon
- Stability due to 3.5 mm deep parallel guide surfaces in the implant and wide plateau on the implant face
- Wide range of restorative options

Once the Friadent abutment screw is tightened, it is not exposed to any horizontal stresses. This effectively prevents screws from loosening and breaking.

Xive® TG: The extended implant neck with external square

Xive TG extended implant neck and external square connection permit

- Clear and fast positioning of the abutment due to eight positioning options
- Simplicity of use and prosthetic flexibility due to one prosthetic diameter (D 3.8) for all implant diameters
- Optimal platform for the premium and cost-effective full arch restorations with Atlantis patient-specific bar or bridge suprastructures due to extended implant neck
- Avoiding of gingiva irritations due to prosthetic protocol on gingiva level
- Surgical flexibility due to same drilling procedure as Xive S



Deep, internal hexagon implant-abutment connection with rotation lock

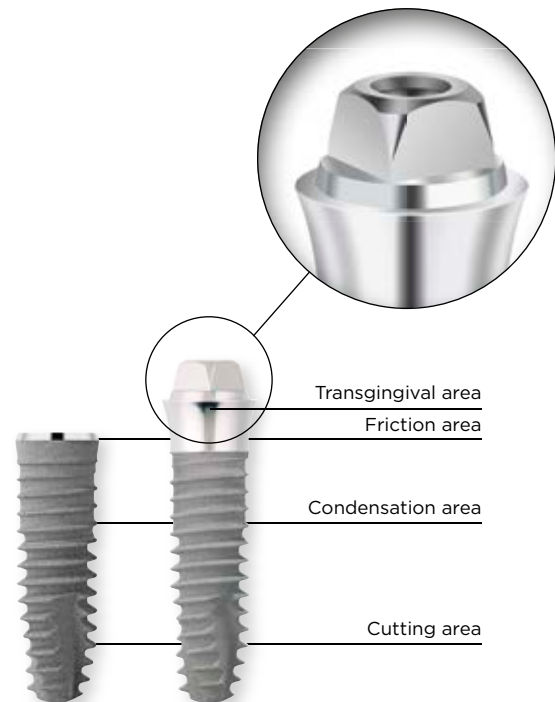

Xive S and Xive TG with self-cutting threads and special core design for internal condensation

Easy and versatile prosthetics

The Xive® Esthetic concept – Individualized contouring of the emergence profile

For the highest level of function and esthetics, a treatment concept using anatomically designed components is ideal. The Xive Esthetic concept consists of four treatment steps for using pre-fabricated, yet customizable, components of the Xive system. The surgical protocol is adapted to the bone quality, and an emergence profile is created using the unique TempBase. During impression taking, the contoured emergence profile is captured with an individualized transfer coping. The final restoration can be fabricated using either the option of a patient-specific Atlantis Abutment or a two-piece option with the Xive TitaniumBase.

Xive® TG and Atlantis® – Premium and cost-effective full arch restorations

Atlantis patient-specific bar or bridge suprastructures on transgingival Xive TG implants provide all the benefits of function and esthetics and cost-effectiveness. The one-stage surgical protocol saves time and money and is comfortable for the patient. Due to the transgingival implant design, additional abutments for prosthetic restorations are no longer necessary. The prosthesis can be restored at the gingival level with a tension-free Atlantis bridge or bar-supported restoration.

The multifunctional TempBase 3-in-1 concept

The multifunctional TempBase is delivered premounted on all Xive S implants as a placement head. It can then be used as a temporary abutment. Since there is no changing of components, there is no additional compromise to the surrounding tissue structures or additional costs. The pre-fabricated, clippable TempBase Cap ensures a fast and easy temporary restoration closest to that of a final crown with a single-stage chairside procedure immediately after implant placement.

In the case of submerged healing, an impression can be taken using the TempBase directly after surgery. The dental laboratory can use this impression to fabricate a high-quality, precision-fit temporary restoration during the healing period, which can then be immediately placed after second-stage surgery.



Atlantis Abutments

Atlantis implant suprastructures

Xive TempBase and Friadent TempBase Cap

The Platform-Switch concept – experience the freedom in prosthesis fixation

Some factors that impact bone level and soft tissue health around the implant are construction-related and can have a large effect on treatment success.

For example, the use of diameter-reduced abutments, referred to as “Platform-switching” (PS), can help to maintain bone levels and soft tissue health.

Bone maintenance with Platform-Switch

The specific design of the beveled, polished implant collar with the integrated option for platform-switching is a key feature of the Xive design. In combination with the use of reduced-diameter abutments, this results in a positive effect on peri-implant tissues. To achieve a successful restoration following the platform-switching concept, it is essential not only to use the reduced-diameter final abutment, but also to start with a reduced-diameter Cover Screw and continue with the corresponding prosthetic components. The Xive prosthetic portfolio includes all of these components.



The SmartFix® concept – The prosthetic solution on angled implants

The SmartFix concept is a time-saving treatment for immediate loading on four implants with screw-retained restorations. It provides a stable prosthetic fit and avoids critical anatomical areas by using implants placed on an angle, provided with 15° or 30° angled Xive MP Abutments.

For prosthetic restorations, either a conventionally-fabricated superstructure or Atlantis suprastructures with a high precision fit can be selected.

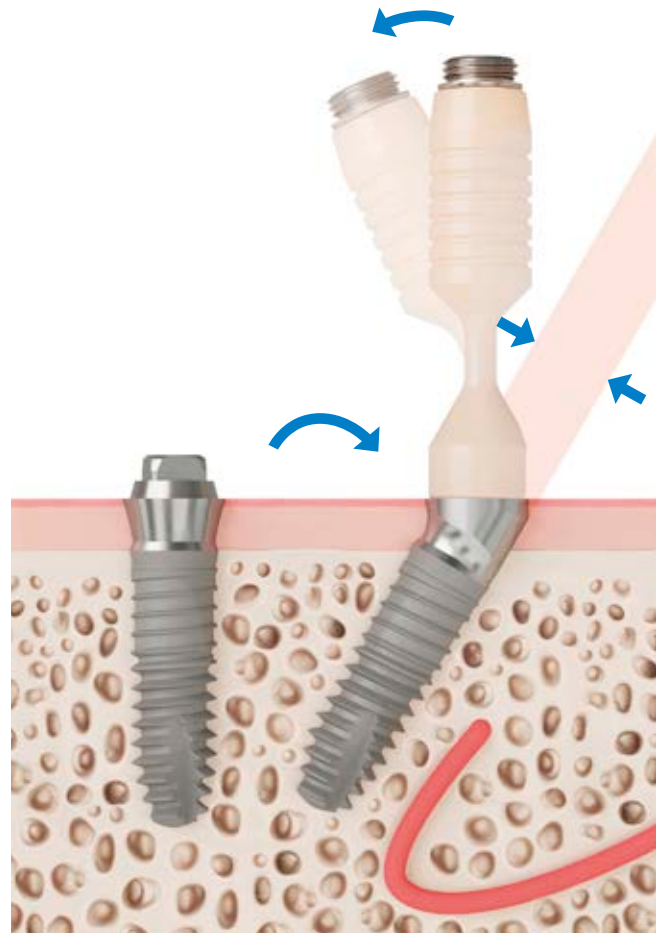

Treatment planning

Aspects of treatment planning

Treatment planning is based on a comprehensive consultation with the patient, which is used to determine exactly what the patient wants and expects from the treatment, discover any possible contraindications and to explain the treatment in detail to the patient.

It is followed by a complete general and specific medical history and intraoral diagnosis with analysis of the initial anatomical situation.

The following points must be considered:

- Medical history
- General diagnosis – exclusion of contraindications
- Specialist consultation for risk factors
- Detailed intraoral diagnosis (PAR diagnosis, functional examination, reasons for tooth loss, evaluation of the old denture, general radiology examination)

The treatment plan can be prepared after examination and evaluation of all diagnostic documentation.

The plan should include:

- Pre-prosthetic planning
- Surgical planning
- Schedule
- Cost schedule

Accurate planning of every implant procedure is essential for the long-term success of the treatment. The planning process defines all actions and lists alternatives that can meet the patient's expectations of the function and esthetics of the implant-prosthetic rehabilitation.

Indications for Xive® S and Xive® TG

Xive implants make an excellent prosthetic restoration for all surgical indications possible. Xive implants are particularly good in situations as follows:

- Grafting is not wanted or is not indicated (e.g., atrophied alveolar ridge, multiple implant-supported restorations in posterior regions)
- A cylindrical implant design offers advantages - particularly in the posterior tooth region
- In indications where the maximum possible use of the local bone is required (implant lengths 8 mm to 18 mm)
- High primary stability is required for immediate function of implants
- Immediate or delayed implant placement is planned

Features specially for Xive® S

The two-piece Xive S implants allow submerged healing as well as a single-stage procedure, possibly with fabrication of a high-quality temporary denture with the Xive TempBase at the time of implant placement.

Xive S is ideal in situations such as:

- Limited interalveolar volume - smallest implant diameter D 3.0
- Temporary and definitive components are wanted for a simple and fast prosthetic restoration
- A high degree of prosthetic flexibility is required

Features specially for Xive® TG

Xive TG is a one-piece, transgingival option for situations in which:

- A single-stage, implant-supported restoration is desired
- A cost-effective full arch restoration is indicated



Conventional treatment planning

Pre-prosthetic planning

Pre-prosthetic planning with the dental technician is the most important factor for the esthetic and functional success of the implant procedure. The target is the best possible tooth-analog placement of the implants.

During the first planning session with the patient, impressions are taken for use as the base for laboratory fabricated diagnostic aids.

A diagnostic wax-up of the planned prosthetic restoration is made.

A thermoformed splint with radiographic balls that can be accurately repositioned in the patient's mouth is prepared. It can be subsequently modified into a conventionally-fabricated surgical template.

The pre-prosthetic planning is simplified with the Friadent Select components.

Surgical planning

The surgical template, which is used to transfer the pre-prosthetic planning to the clinical situation, is fabricated on completion of the surgical and prosthetic treatment planning.

The correct seating of the surgical template must be checked in the oral cavity. The width of the vestibular and oral lamellae should be at least 1.5 mm. The position and direction of important anatomical structures such as the mental foramen or maxillary sinus must be determined by radiographs. Grafted regions must be confirmed to have completely regenerated to a mechanically stable state before preparation.

Planned prosthetic measures must be checked to ensure that they can actually be implemented with reasonable surgical procedures. All aspects of pre-prosthetic and surgical planning interact directly with one another. Every change in the pre-prosthetic planning will affect the surgical planning and vice versa. This also includes the number, diameters, length, position and alignment of the implants. The available bone volume and important anatomical structures are examined in a radiographic image, which is prepared with the laboratory-fabricated radiographic template with the radiographic balls in the patient's mouth.

The dimensions inside the oral cavity can be calculated accurately from the defined diameter of the radiographic balls. The implant lengths are selected by placing the transparent Xive x-ray template on the OPG.



Diagnostic Wax-up.



Thermoformed splint with radiographic balls.



Xive radiographic template.

Computer-guided treatment planning

Simplant® software

Digital treatment planning based on three-dimensional imaging enables the therapy to be planned with absolute accuracy and makes the result of the treatment predictable.

Guided surgery from Dentsply Implants includes a complete solution for digital treatment planning and template-guided implant placement based on the Simplant software.

The advantages of digital treatment over conventional planning include:

- Safe three-dimensional planning in the submillimeter range and with reference to the desired restoration
- Automatic collision control, which indicates inadequate clearances between implants or to the nerve (inferior alveolar nerve)
- Information on peri-implant bone quality for assessment of possible primary stability

Simplant® SAFE Guide

A patient-specific Simplant SAFE Guide is fabricated by stereolithography using the digital planning data. This guarantees that the planning will be fully and accurately transferred to the patient's mouth, even in the posterior region, due to the unique drill guide with lateral access.

The Sleeve-on-Drill system (drills with a guide sleeve attached to the instrument), which has been especially developed for template-guided implant placement, enables exact transfer of the planned implant position and secures placement of the implants.

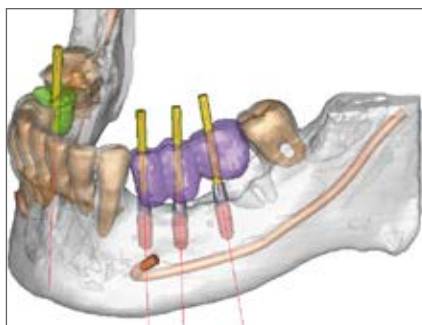

Digital treatment planning with Simplant.



Patient-specific Simplant drill guide.



Sleeve-on-Drill system and drill guide with lateral access.

Implant healing & exposure

Implant healing

Submerged - transgingival - immediately restored - immediately loaded

After insertion of the implants, the Xive system enables various healing modes depending on the indication and type of planned restoration:

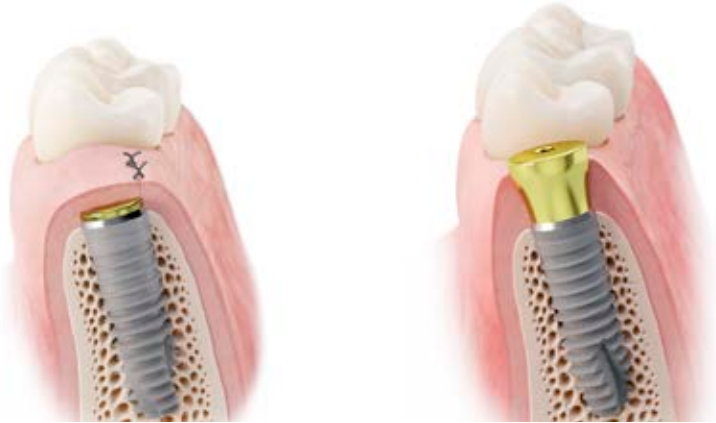

Submerged healing

In the case of a two-stage treatment protocol with submerged healing, seal the implant with the Cover Screw and suture the mucosa over the implant. A load-free healing period must be ensured. As a general rule, the implant should be left to heal between three and four months, regardless of the location in the mandible and maxilla. In the case where augmentation is simultaneously performed, the healing time must be extended accordingly.

Transgingival healing

Transgingival healing of the implants makes it possible to avoid a second surgical procedure. It also allows for optimal soft tissue healing and the formation of an ideal emergence profile. The implant is sealed with a gingiva former.

The geometry of the subsequent prosthetics can already be taken into consideration when selecting the diameter. Since the gingiva former is a separate component to the implant in contrast to the one-piece transgingival implants, an abutment with another emergence height can be selected during the healing period, hence ensuring esthetics.

- Submerged after placing the Cover Screw
- Transgingival with gingiva former or immediate restoration with Xive TG
- Immediate restoration/immediate loading

The multifunctional Friadent TempBase is premounted on all Xive S implants as a placement head. In many cases, the unique TempBase concept for Xive allows for immediate high-quality temporary restoration. Immediate loading of the implants is also possible under adequate conditions.



Immediate restoration

If the clinical prerequisites for an immediate restoration with a temporary restoration are met, it is an excellent opportunity to provide the patient with an implant-supported restoration immediately after implant placement. Second-stage surgery is no longer necessary, and the patient is able to see an immediate result.

Immediate loading

An immediately-loaded, bar-supported prosthesis can be fabricated on at least four Xive TG implants placed interforaminally in the mandible.

Xive S implants D 3.4 - D 5.5 are suitable for both one-stage and two-stage procedures as well as for cement-retained, removable or screw-retained restorations. With appropriate occlusal loading, Xive S implants D 3.4 - D 5.5 can be used for immediate implant placement or immediate loading if sufficient primary stability can be achieved. Multiple restorations can be splinted.

Step-by-step: Implant exposure

In the case of submerged healing of the implant, the minimally-invasive exposure of the implants usually takes place after three to four months, followed by contouring of the soft tissue, as described below. In the case of transgingival healing of the implants or in the case of an immediate restoration with a

short-term temporary restoration, the following steps are not necessary. If needed, a customized temporary restoration can be fabricated (see page 19) or the impression can be taken immediately (see page 36).



Incision

After locating the implant and administering anesthesia directly over the implant (e.g., intraligamentary system), a crestal incision is made to expose the Cover Screw. Locating the implants can be facilitated by re-using the drill guide.

Exposure

Spread the wound edges slightly using an angled rasp until the Cover Screw is visible. The central thread of the Cover Screw is located using the probe. Remove as little connective tissue or bone as possible above the Cover Screw using the cup curette, if necessary.

Removing the Friudent Cover Screw

Insert the Hex Driver 0.9 mm for ratchet or contra-angle handpiece into the internal hex of the color-coded Cover Screw and turn it counterclockwise out of the implant. Clean and dry the internal hex of the implant with air-water spray before inserting the gingiva forming component.

Soft tissue management and temporary solutions

For details regarding Platform-Switch options please see pages 48-49.

An alternative procedure

An alternative procedure

An alternative procedure



Friadent TempBase - Temporary solution included

Every Xive S implant is delivered with a pre-mounted TempBase, which can be used to manufacture a temporary restoration or for an index impression taking with the aid of the Friadent TempBase Cap.

More detailed information about the Friadent TempBase and step-by-step instructions on the use are provided on pages 16-19.

Xive Gingiva Former C - Optimal healing and contouring

The Xive Gingiva Former C provides a circular contouring of the peri-implant soft tissue by a close attachment of the gingiva. Xive Gingiva Formers C are also available in slim and PS versions.

More detailed information about the Xive Gingiva Former C and step-by-step instructions on the use are provided on pages 20-21.

Friadent EsthetiCap - Temporary solution for esthetic contouring

The Friadent EsthetiCap offers the option of customizable temporary restoration and contouring of the soft tissue for esthetically demanding restorations.

More detailed information about Friadent EsthetiCap and step-by-step instructions on its use are provided on pages 22-23.

Step-by-step: Xive® TempBase concept, temporary single tooth restoration

The following example shows the chairside fabrication of a temporary crown using a pre-fabricated plastic tray.



Placing the Friadent TempBase Cap

Leave the Friadent TempBase abutments on the implants or, if necessary, reinsert them.

Select a Friadent TempBase Cap according to the implant/TempBase diameter. For fabrication of a temporary crown, remove the lateral retention slot and the diamond-shaped head of the Friadent TempBase Cap.

Place the modified TempBase Cap on the TempBase.

Polymerizing the temporary crown

Modify the prepared thermoformed splint or the pre-fabricated plastic tray (e.g., Frasaco) to be placed over the TempBase without difficulty. Then, coat with tooth-colored plastic, position and polymerize. Place a rubber dam in the oral cavity before using polymerizates to prevent irritation of the mucosa or an allergic reaction.

Before using polymerizates, please see the manufacturer's instructions for use.

Preparing the temporary crown

Remove and trim the temporary crown.

Place the prepared temporary crown on the Friadent TempBase abutment with temporary cement.

Grind the temporary restoration so it is out of contact for occlusion and articulation.

Step-by-step: Temporary restoration of multiple implant placement

A temporary bridge is fabricated using the same procedure as described before for the case of a single tooth restoration. However, the Friadent TempBase Caps must be firmly connected with multiple implants.



Placing the Friadent TempBase Caps

Leave the Friadent TempBase abutments on the implants or, if necessary, reinsert them.

After removal of the diamond-shaped head, position the appropriate Friadent TempBase Caps on the TempBase abutments until the parts securely engage.

Modify the prepared vacuum-formed splint so it can be placed over the TempBase Caps without interference, and then remove after the try in.

Splinting of the Friadent TempBase Caps

Place a band coated with light-curing plastic in the lateral retention slots to fix the position of the TempBase Caps in relation to one another and for mechanical reinforcement of the temporary bridge.

When manufacturing a temporary bridge structure, the lateral retention slot of the TempBase Cap must remain intact.

Polymerizing and placing the temporary bridge

Apply tooth-colored resin to the splint, mount it, remove excess, and polymerize.

Take off the temporary bridge, prepare and, if applicable, place with temporary cement.

Step-by-step: Xive[®] TempBase concept, index impression

Chairside procedure



Placing the TempBase Cap

Leave the Friadent TempBase abutment on the implant or, if necessary, reinsert it for the index impression.

After removing the lateral tab, position a TempBase Cap of the right size on the TempBase until the parts securely engage.

The index impression is ideally taken with a drill template fabricated on a model before surgery.

Relieving the drill template

Hollow-grind the drill template to allow it to be placed correctly on the TempBase Cap.

Impression taking

Fill the template with a polymerizable (pattern resin or light-curing composite such as CronMix K plus, Merz Dental GmbH) placed on the TempBase Cap and polymerized.

Place a rubber dam in the oral cavity before using polymerizates to prevent irritation of the mucosa or an allergic reaction.

Before using polymerizates, please see the instructions in the manufacturer's instructions for use.

An alternative procedure

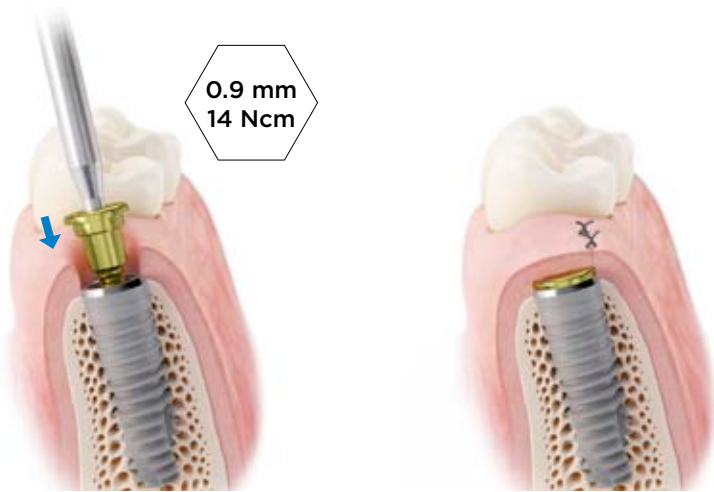

Placing the Friadent Cover Screw

Remove the template once the polymerizate has set.

Remove the TempBase with the Hex Screwdriver 0.9 mm. Use the same screwdriver to place the Friadent Cover Screw.

Suturing

Suture the wound to prevent the ingress of bacteria and saliva.

Send the impression and the TempBase to the laboratory for further processing.

After osseointegration, expose the implant and prepare the temporary restoration on the TempBase with the aid of the TempBase Cap.

In the laboratory

During the healing period, the laboratory fabricates a master cast that shows the exact implant position at the time of implant placement.

On this master cast, an individual temporary restoration is manufactured, which can be delivered to the patient immediately after exposure of the implants.

Step-by-step: Xive® Gingiva Former C

The Xive Gingiva Formers C are for or simple contouring of the peri-implant soft tissue. The curved emergence profile - gives space to improve esthetic outcome.



A gingiva former is placed for soft tissue contouring during the healing period
(Photos: H. Salama, DMD and M. Salama, DMD, Atlanta, GA/USA).



The mucosa is adapted and fixed in position by sutures.



Xive Gingiva Former C
and Xive Gingiva Former PS C

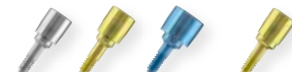

Xive Gingiva Former slim C
and Xive Gingiva Former PS slim C

Xive Gingiva Former C

- Curved emergence profiles - matching impression copings and final abutments
- Titanium alloy
- 1.22 Hex screwdriver connection - hand-tightening
- Solid color-coded
- Laser tagged on the top



The following are optionally available:

Xive Gingiva Former slim C

- For perfect contouring of the soft tissue with limited mesio-distal space



For details regarding Platform-Switch options, please see pages 48-49.

Xive Gingiva Former PS C

- For contouring of the soft tissue when a restoration with diameterreduced abutments is planned
- Supports the security of achieving long-term esthetic outcomes



Xive Gingiva Former PS slim C



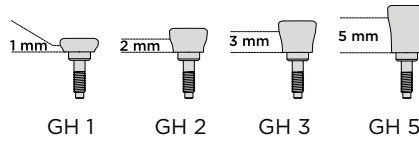

The Xive Gingiva Former C is screwed in hand-tight with a 1.22 hex-screwdriver.

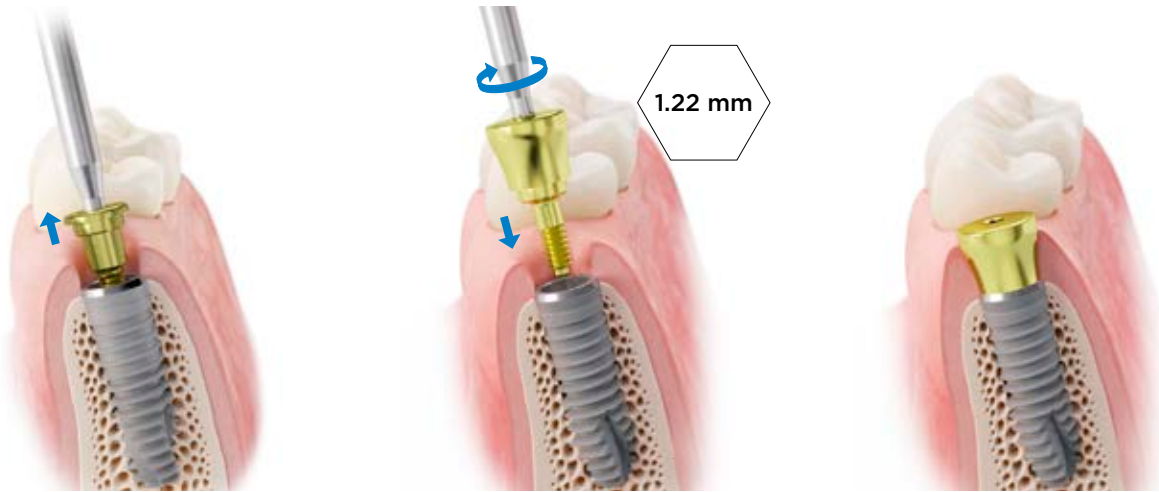

Removing the Friadent Cover Screw

After implant exposure, unscrew the Friadent Cover Screw and remove it using the Hex Screwdriver 0.9 mm. The internal implant geometry can be cleaned and rinsed.

Placing the Xive Gingiva Former C

Select the gingiva former corresponding to the implant diameter interdentary space and gingival height. Place it with the Hex Screwdriver 1.22 mm and screw it in hand-tight. In special cases such as restricted space use the Gingiva Formers slim. All gingiva formers are color-coded and laser-tagged according to their diameter.

Suturing

Adapt and tightly suture the soft tissue around the gingiva former without tension.

Grind the existing temporary denture, such as a clasp denture or a bridge fixed to adjacent teeth, before delivery to ensure that there is no pressure on the gingiva former. A final prosthetic restoration of the implant should be placed only after the peri-implant soft tissue has healed without irritation.

Step-by-step: Friadent® EsthetiCap

Friadent EsthetiCap is an anatomically shaped abutment for manufacturing screw- or cement-retained temporary crowns or bridges. It can be adapted as a patient-specific gingiva former for esthetic soft tissue contouring.



EsthetiCap as a customized temporary abutment for optimal shaping of the emergence profile.



Clinical Case: MDT Renzo Casellini, Los Angeles, CA, USA

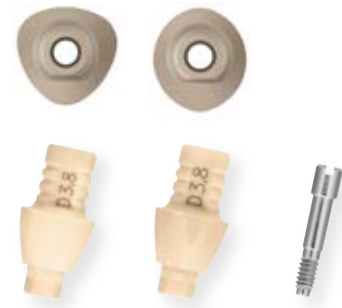

Friadent EsthetiCap, oval and triangular with screw for EsthetiCap

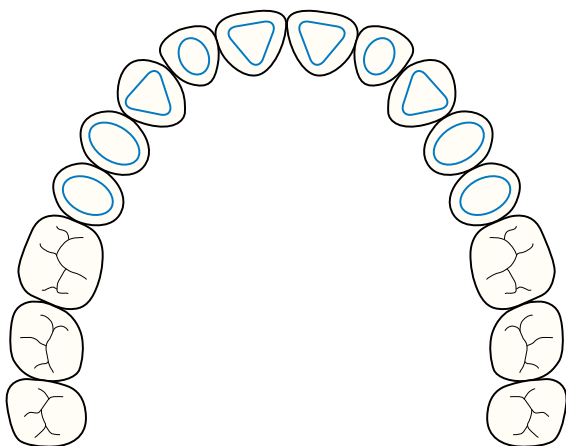

Friadent EsthetiCap

The Friadent EsthetiCap offers the option of customizable temporary restorations and contouring of the soft tissue for esthetically demanding situations.

- For esthetically demanding temporary crowns and bridges
- Two anatomical profiles – oval and triangular
- Customizable by grinding or layering
- Cementable
- X-ray-opaque due to zirconium dioxide additives
- Not available for implants D 3.0

Due to a patented compound of PEEK and zirconium dioxide additives, the EsthetiCap is x-ray-opaque and easy to grind.

An alternative procedure



Placing the Friadent EsthetiCap

After implant exposure, unscrew and remove the Friadent Cover Screw using the Hex Driver 0.9 mm. The internal implant geometry can be cleaned and rinsed.

Use the Hex Driver 0.9 mm and the prosthetic ratchet or a torque-controlled contra-angle handpiece with Hex Driver for contra-angle handpiece 0.9 mm to screw the EsthetiCap to 14 Ncm.

Friadent EsthetiCap as a temporary restoration

Temporary restorations on a Friadent EsthetiCap can be either cement-retained or directly veneered.

The restoration is cement-retained with temporary cement. Excess cement should be thoroughly removed from the crown margins.

Grind any existing temporary restoration before positioning in order to prevent pressure from being exerted on the EsthetiCap.

A final prosthetic restoration of the implant should be placed only once the peri-implant soft tissue has healed without irritation.

Friadent EsthetiCap as a gingiva former

Adapt and tightly suture the soft tissue around the EsthetiCap without tension.

When using the Friadent EsthetiCap as a gingiva former, the abutment must be shortened to the corresponding gingival height.

Optimal contouring of the emergence profile can be achieved when using the EsthetiCap as a customized gingiva former.

Xive[®] S prosthetics

Basics of Friadent[®] / Xive[®] S prosthetics





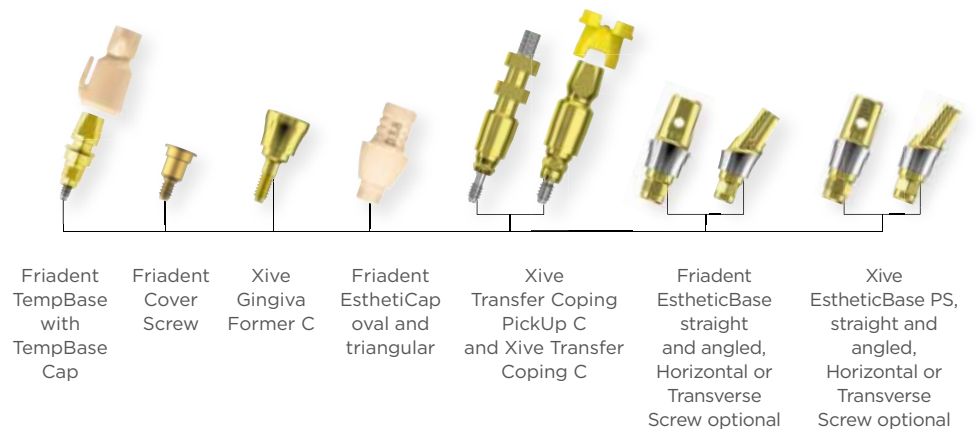

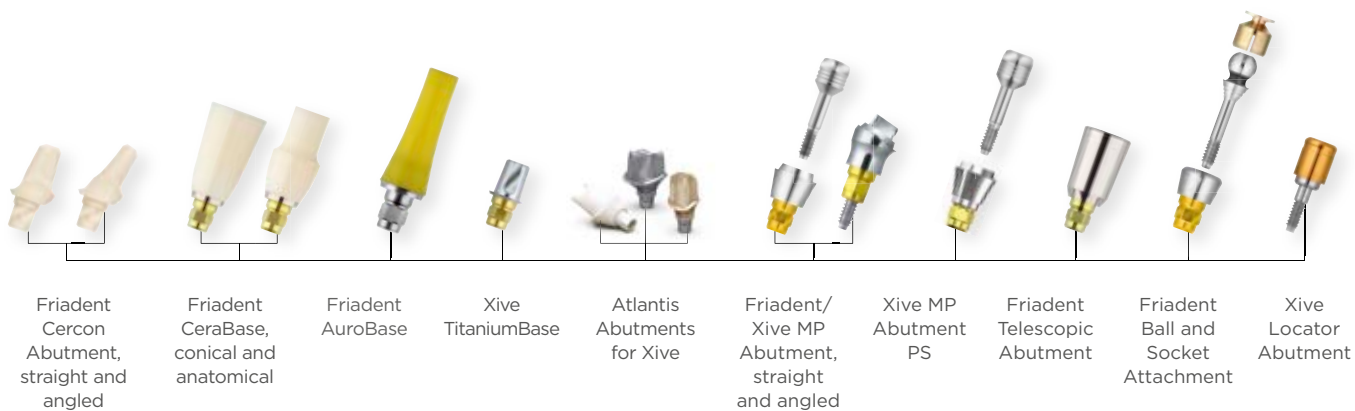





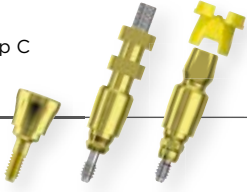





A range of pre-fabricated and patient-specific abutments offers versatile prosthetic options on both the implant and abutment levels, including immediate restorations for almost every possible indication.

The internal connection with self-guiding properties and the color-coded or laser-marked components supports reliable and efficient work processes.





Using the Friadent® screwdrivers

<p>HAND TIGHT</p>  <p>Friadent Hex Driver Width across flats of 1.22 mm</p> <p>hand-tight</p>	<p>14</p>  <p>Friadent Hex Driver Width across flats of 0.9 mm</p> <p>14 Ncm</p>				
<p>Xive Gingiva Former C Transfer Coping Pick Up C Transfer Coping C</p> 	<p>Friadent TempBase</p> 	<p>Friadent Cover Screw</p> 	<p>Friadent MP Cover Screw</p> 	<p>Friadent Horizontal and Transverse Screw</p> 	
<p>24</p>  <p>Friadent Hex Driver Width across flats of 1.22 mm</p> <p>24 Ncm</p>					
<p>Friadent Standard Abutment Screw Friadent Screw for EstheticBase</p> 	<p>Friadent MP PickUp Guide Pin Friadent PickUp Guide Pin</p> 	<p>Friadent MP Screw for Castable Sleeve Xive TG Abutment Screw</p> 	<p>Friadent MP Coping Screw Xive TG Coping Screw</p> 	<p>Friadent Attachment Screw</p> 	<p>Atlantis Screw</p> 
<p>24</p>  <p>Friadent Seating Instrument for MP Insert Screw</p> <p>24 Ncm</p>	<p>30</p>  <p>Friadent Locator Insert for Prosthetic Ratchet</p> <p>30 Ncm</p>				
<p>Friadent MP Insert Screw</p> 	<p>Xive Locator Abutment</p> 				

Xive® S prosthetic navigator

The Xive system offers various options for manufacturing the superstructure depending on the indication and type of prosthetic restoration.

Due to the variety of the abutments, a decision on the prosthetic procedure is still possible after the implants heal or at the time of implant exposure. This allows you to achieve the best functional and esthetic solution for each case.

Fixed solutions



Single tooth replacement

Cement-retained

Crown/anterior region:

- Friadent Cercon Abutment
- Friadent CeraBase Abutment
- Friadent EstheticBase Abutment

Crown/anterior and posterior region:

- Friadent EstheticBase Abutment
- Friadent AuroBase Abutment
- Xive TitaniumBase Abutment
- Atlantis Abutment for Xive

Screw-retained

Crown/anterior and posterior region:

- Friadent EstheticBase Abutment (horizontal/transversal)
- Friadent AuroBase Abutment (horizontal/occlusal)
- Atlantis Crown Abutment for Xive
- Xive TitaniumBase screw-retained crown (occlusal)



Larger tooth gaps

Edentulous jaw

Bridge/anterior and posterior region and full-arch restorations:

- Friadent EstheticBase Abutment
- Friadent AuroBase Abutment
- Xive TitaniumBase Abutment
- Atlantis Abutment for Xive

Bridge/posterior region and full-arch restorations:

- Friadent MP Abutments/
Friadent PassivFit

Bridge/anterior and posterior region and full-arch restorations:

- Friadent EstheticBase Abutment (horizontal/transversal)
- Friadent AuroBase Abutment (horizontal)
- Friadent MP Abutments/SmartFix concept:
 - Friadent Castable/Cast-to Waxing Sleeve
 - Atlantis Bridge/Hybrid
- Xive WeldOne concept

Removable solutions



Edentulous jaw

- Xive Locator
- Friadent Ball and Socket Attachment
- Friadent Telescopic Abutment
- Friadent AuroBase Abutment
- Friadent MP Abutment
- Friadent MP Abutment with Atlantis bar
- Friadent MP Abutment with Atlantis 2in1 solution
- Atlantis Conus Abutment

Detailed instructions for selecting the most suitable restorative procedure for the individual case can be found on the following pages.

Solutions for single tooth restorations



Cement-retained

Anterior and posterior region

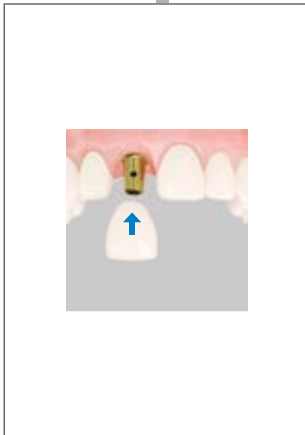

Friident EstheticBase/ Friident AuroBase

The Friident EstheticBase Abutment with pre-fabricated screw holes for horizontal or transverse screws can be customized and has an anatomically contoured shoulder, available in various gingival heights.

The Friident AuroBase Abutment serves as the basis for fabrication of individual crown abutments as well as of cement-retained or individually screw-retained crowns.

For instructions, see pages 52, 58.



Friident Cercon* Abutment/ Friident CeraBase*

The restorations on Cercon zirconium dioxide ceramic abutments provide superior esthetics for the anterior region and, at the same time, excel with extremely high stability.

The abutment can be customized and is available in versatile designs. Two shades of white for the outstanding biocompatible material provide for the perfect integration of the cement-retained crowns.

*only in the anterior region

For instructions, see pages 55, 57.



Xive TitaniumBase

The Xive TitaniumBase combines the proven strength of a pre-fabricated titanium abutment with the esthetics of an individually designed ceramic component.

This solution allows the dental laboratory to design and manufacture a CAD/CAM restoration within their preferred workflow.

For instructions, see page 62.

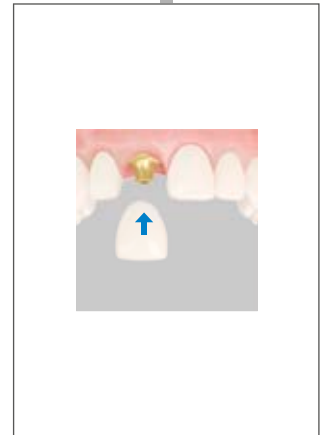

Patient-specific Atlantis abutment

The Atlantis abutments enable patient-specific cement-retained (Atlantis Abutments) and single tooth screw-retained (Atlantis Crown Abutment) restorations in the anterior and posterior region and represent an excellent base for the best possible results in both function and esthetics.

For instructions, see page 64.



Screw-retained

Anterior and posterior region



Friadent EstheticBase (horizontal/transversal)

The Friadent EstheticBase Abutment with pre-fabricated screw holes for horizontal or transverse screws can be customized and has an anatomically contoured shoulder, available in various gingival heights.

This abutment can be used to fabricate both cement-retained and laterally screw-retained single crowns.

**For instructions,
see page 52.**

Friadent AuroBase

The Friadent AuroBase Abutment serves as the basis for fabrication of individual crown abutments as well as of cement-retained or individually screw-retained crowns.

The castable plastic cylinder enables almost unlimited individuality in the design of the abutment.

**For instructions,
see page 58.**

Patient-specific Atlantis Crown Abutment

The Atlantis Crown Abutment is an efficient, effective and esthetic alternative to traditional cast abutments for single tooth, screw-retained restorations with porcelain or composite applied directly to the abutment.

The Atlantis Crown Abutment is available in five shades of zirconia, including a translucent option in white as well in titanium.

**For instructions,
see page 65.**

Xive TitaniumBase screw-retained crown

The Xive TitaniumBase combines the proven strength of a pre-fabricated titanium abutment with the esthetics of an individually designed ceramic component.

The Xive TitaniumBase occlusally screw-retained single tooth crown makes it possible for the dental laboratory to produce esthetic ceramic veneered or full contour crowns glued onto the TitaniumBase.

**For instructions,
see page 62.**

Fixed solutions for larger tooth gaps and the edentulous jaw



Cement-retained restorations

Anterior and posterior region



Friadent EstheticBase

Friadent EstheticBase Abutments with pre-drilled holes for horizontal or transverse screws can be customized. They have an anatomically contoured shoulder, available in various gingival heights. These abutments can be used to support both cement-retained and laterally screw-retained bridges.

For instructions, see page 52.



Friadent AuroBase

For the fabrication of customized abutments using the bridge technique, the Friadent AuroBase can be used in cases presenting special challenges such as large axial divergences or a small interocclusal clearance. Bridge constructions on AuroBase can be fabricated as cement-retained or horizontally screw-retained restorations.

For instructions, see page 58.

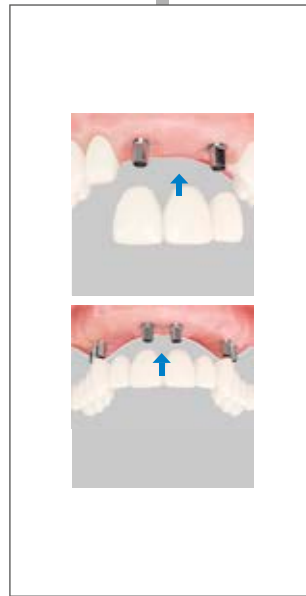

Xive TitaniumBase

The Xive TitaniumBase combines the proven strength of a pre-fabricated titanium abutment with the esthetics of an individually designed ceramic component.

This solution allows the dental laboratory to design and manufacture a CAD/CAM bridge restorations within their preferred workflow.

For instructions, see page 62.

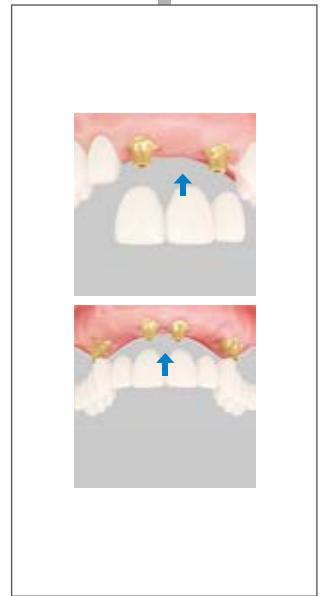

Patient-specific Atlantis Abutments

Patient-specific Atlantis abutments are an ideal alternative to pre-fabricated abutments.

Atlantis abutments support cement-retained bridge restorations in the anterior and posterior region and represent an excellent base for the best possible results in both function and esthetics.

For instructions, see page 64.



Screw-retained restorations

Anterior and posterior region

The SmartFix concept

The WeldOne concept

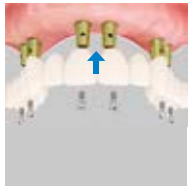

Friadent EstheticBase/ Friadent AuroBase

Friadent EstheticBase Abutments can be used to fabricate horizontally and transversally screw-retained restorations on multiple implants with bridges.

For the fabrication of customized abutments with the bridge technique, the Friadent AuroBase is used in challenging cases.

For instructions, see pages 52/58.

Xive/Friadent MP Abutments

The Friadent MP Abutment is used to fabricate screw-retained bridge frameworks for restoring multiple implants.

Friadent Castable and Cast-to Waxing Sleeves are used to fabricate screw-retained bridges on Xive/ Friadent MP Abutments.

For instructions, see pages 71/76.

Xive/Friadent MP Abutments with the Atlantis Bridge/Hybrid

Atlantis implant supra-structures are digitally designed using the scanned-in diagnostic tooth set-up.

The Atlantis Bridge is compatible with ceramic or resin veneering.

For instructions, see page 80.

WeldOne concept for Xive

The WeldOne concept allows immediate restoration of implants with a stable, tension-free fitting framework construction for temporary and durable restorations on the day of implant placement.

For instructions, see page 84.

Removable solutions for the edentulous jaw



Removable overdentures



Xive Locator

The Locator Abutment provides long-term stability and ease of use. The low vertical height is ideal for the majority of all overdenture patients. Axial divergences and limited occlusal space can be easily corrected using Locator.

For instructions, see page 90.



Friadent Ball and Socket Attachment

The Friadent Ball and Socket Attachment offers an economical possibility for stabilization of overdentures in the mandible with outstanding potential for oral hygiene.

The restoration can be fabricated either directly chairside or a prosthesis is manufactured in the dental laboratory.

For instructions, see page 94.



Friadent AuroBase

For the fabrication of customized abutments using the bridge technique, the Friadent AuroBase is used for cases presenting special challenges such as large axial divergences or a small interocclusal clearance. Bridge constructions on AuroBase can be fabricated as cement-retained or horizontally screw-retained restorations.

For instructions, see page 58.



Friadent Telescopic Abutment

The Friadent Telescopic Abutment is used to secure overdentures on telescopic or conical crowns.

The Friadent Telescopic Abutment, made of titanium, represents the primary component and allows customized preparation, even with axial divergences.

For instructions, see page 96.

The SmartFix concept

The Atlantis Conus concept

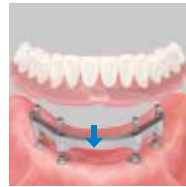
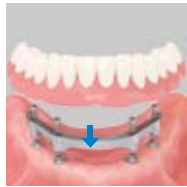

Friadent MP Abutment/bars

In combination with MP abutments, Friadent Bar Copings are used for the fabrication of bar constructions. They are offered as pre-fabricated components for both soldering and laser welding.

For instructions, see page 100.

Friadent MP Abutment/Atlantis bar

Patient-specific Atlantis bar-supported restorations provide tension-free fixation of removable, implant-supported CAD/CAM prostheses with utmost precision.

For instructions, see page 102.

Friadent MP Abutment/Atlantis 2in1 solution

The primary structure consists of an individual bar, the secondary structure of a bridge or hybrid design. The secondary structure is compatible with a resin veneering technique (bridge) or for individually positioned synthetic teeth (hybrid).

For instructions, see page 103.

Atlantis Conus concept

The Atlantis Conus concept is a unique implant-supported solution for creating a cost-effective, friction-retained, non-resilient and removable overdenture with the comfort of a fixed bridge, providing your patients with renewed comfort and confidence.

For instructions, see page 104.

Impression taking

Instrument Set/ Prosthetic Tray

For a seamless course of treatment, all instruments are clearly arranged and fixed.

The Xive prosthetic tray includes a handpiece hex driver in 0.9 mm and 1.22 mm (short and long) versions and a torque-controlled screwdriver for manual and ratchet application in all versions (hex 0.9 mm with 14 Ncm, hex 1.22 mm with 24 Ncm). The instruments for tightening MP screws and the Friadent ball and socket attachments by hand or ratchet are included in the tray as well.

As with all manual screwdrivers, torque control is achieved by a special mechanism in the head of the screwdriver insert, which audibly clicks once a pre-set torque is achieved. All screwdrivers are made of surgical stainless steel.

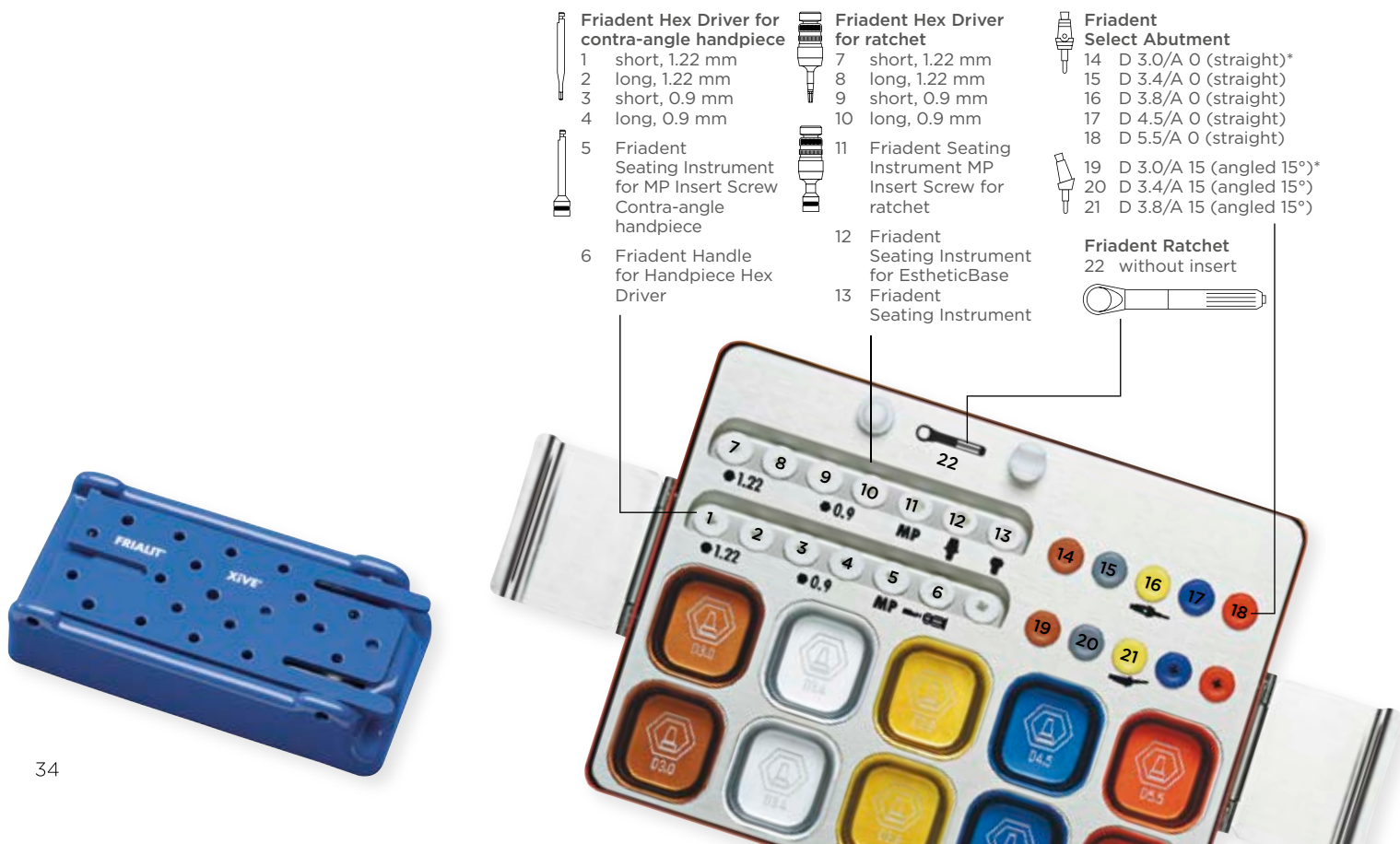

Friadent Prosthetic Set Mini

The Friadent Prosthetic Set Mini contains all instruments necessary for the prosthetic restoration of implants (not included: MP abutment seating instruments).





- | | | |
|--|--|--|
| 
Friadent Hex Driver for contra-angle handpiece
1 short, 1.22 mm
2 long, 1.22 mm
3 short, 0.9 mm
4 long, 0.9 mm

5 Friadent Seating Instrument for MP Insert Screw Contra-angle handpiece

6 Friadent Handle for Handpiece Hex Driver | 
Friadent Hex Driver for ratchet
7 short, 1.22 mm
8 long, 1.22 mm
9 short, 0.9 mm
10 long, 0.9 mm

11 Friadent Seating Instrument MP Insert Screw for ratchet

12 Friadent Seating Instrument for EstheticBase
13 Friadent Seating Instrument | 
Friadent Select Abutment
14 D 3.0/A 0 (straight)*
15 D 3.4/A 0 (straight)
16 D 3.8/A 0 (straight)
17 D 4.5/A 0 (straight)
18 D 5.5/A 0 (straight)



19 D 3.0/A 15 (angled 15°)*
20 D 3.4/A 15 (angled 15°)
21 D 3.8/A 15 (angled 15°)

Friadent Ratchet
22 without insert |
|--|--|--|

Components for impression taking

Xive Transfer Copings C / Xive Transfer Copings PickUp C precisely capture the vertical and horizontal implant position as well as the orientation of the deep internal hex. They are suitable for all gingiva formers C.

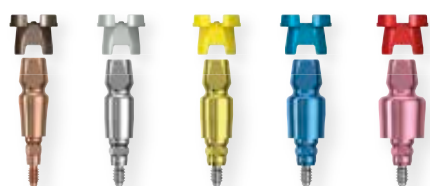
The design of the Friadent MP Abutment provides for an impression on abutment level, after completed osseointegration and soft tissue contouring, without removal of the Friadent MP Inserts and the MP Insert Screw.



Xive Transfer Coping C, Xive TransferCap C



Xive Transfer Coping PS C



Friadent MP Transfer Impression Coping/
Standard Abutment Screw



Xive Transfer Coping PickUp C



Xive Transfer Coping PickUp PS C



Friadent MP PickUp Impression Coping/
MP PickUp Guide Pin

Impression taking on implant level

Xive Transfer Coping PickUp C (open tray technique) / Xive Transfer Coping C (closed tray technique)

- Transferring the implant position to the master model
- Titanium alloy
- 1.22 Hex screwdriver connection – hand-tightening
- Solid color-coded
- Available short and long
- One hand procedure – captive screw for safe handling
- Also suitable for impressions following soft-tissue contouring with the the Xive Gingiva Former slim C

The TransferCoping PickUp C

Short is used in case occlusal height is limited, the long version provides more retention.

The **Transfer Coping C Short** is used for a mucosa thickness of up to 3 mm. The **Transfer Coping C long** is used for a mucosa thickness above 3 mm.

Xive TransferCap C (closed tray technique)

- Transfer Cap C with click-function

Two parallel flat sides stabilize the abutment and prevent it from twisting in the impression material.

Xive Transfer Coping PS C/Xive Transfer Coping PickUp PS C

The platform-switch components for the switch from D 3.8 to D 3.4 are laser-marked with PS.

Impression taking on abutment level

Friadent MP Impression Copings

- For transferring the position of the MP abutment to the master model
- Available for PickUp technique (open tray) and repositioning technique
- The already positioned MP abutment remains in the implant during the impression procedure

To enable a precise impression on abutment level on the inserted MP abutments, color-coded Friadent MP Transfer Impression Copings are available for implant diameters D 3.4 - D 5.5 mm.

Step-by-step: The repositioning technique on implant level, closed tray

Xive Transfer Copings C precisely capture the vertical and horizontal implant position as well as the orientation of the internal hex.

For occlusal fixation, Xive Transfer Copings C are equipped with a captive screw.



Removing the Xive Gingiva Former C

Use the Hex Driver 1.22 mm to unscrew the gingiva-forming component.

Placing the Xive Transfer Coping C

Dependent on the position of the implant, the Xive Transfer Coping C is positioned in the hex of the implant. The Transfer Coping can easily be placed in a unique and precise position using the six options in the hexagon connection.

Check the fit of the Transfer Coping. The soft tissue should not be pinched, but rather should fit closely around it.

Screwing in the Xive Transfer Coping C

The Transfer Coping C is to hand-tighten with the captive screw using the Friudent Hex Driver 1.22 mm.

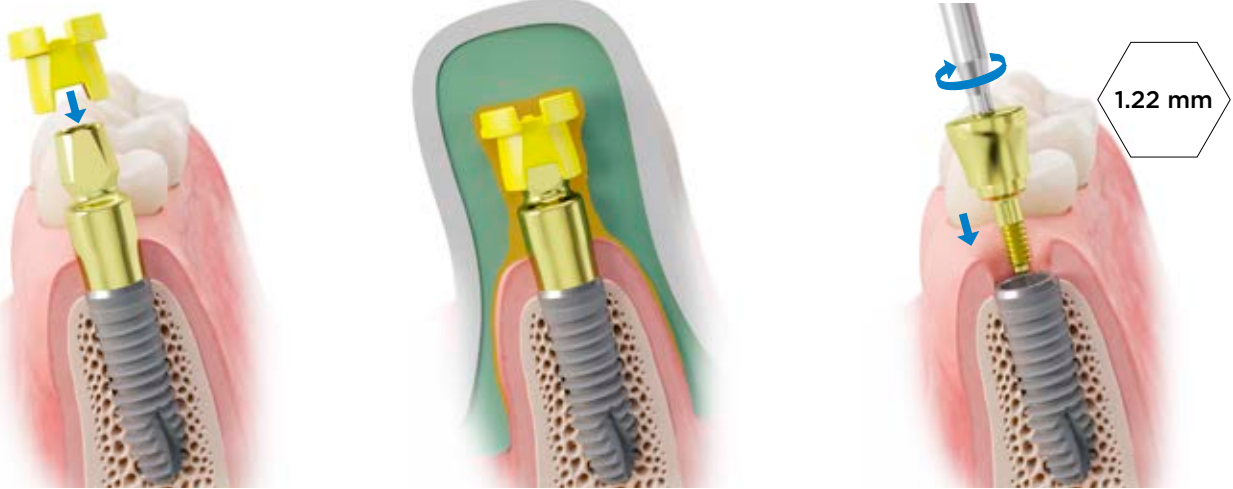

Placing the Xive TransferCap C

Push the Xive TransferCap C onto the Transfer Coping.

Ensure that the flat areas of Transfer Coping C match with the flat areas of the TransferCap C. Click function ensures the correct seating.

Impression taking

Apply impression material around the Transfer Coping. Place the tray, filled with impression material, and make the impression. After the impression material has set, remove the tray; the TransferCap C should remain in the impression.

Before repositioning, connect the implant analog with the Transfer Coping C. When repositioning the Transfer Coping C, its flat areas must align with the flat areas of the TransferCap C.

Reinserting the Gingiva Former

Reposition the Xive Gingiva Former C after the impression is taken. This avoids collapse of the tissue around the implant shoulder.

Step-by-step: The PickUp technique **on implant level**, Xive[®] Transfer Coping PickUp C, open tray

Xive Transfer Copings PickUp C precisely capture the vertical and horizontal implant position as well as the orientation of the internal hex. The design is also to simplify impression procedures on divergently placed implants.

The reduced and slightly conical design of the hexagon part of this abutment enhances easier positioning and repositioning. Deep, distinctive retention areas provide stable and secure retention in the impression material.



Removing the Xive Gingiva Former C

Use the Hex Driver 1.22 mm to unscrew the gingiva-forming component.

Placing the Xive Transfer Coping PickUp C

Dependent on the position of the implant, the Xive Transfer Coping PickUp C can be easily and precisely placed using the six options given by the hex.

Checking the fit of the Xive Transfer Coping PickUp C

For proper seating of the Xive Transfer Coping PickUp C, the soft tissue should not be pinched, but rather fit closely around it.



Screwing in the Xive Transfer Coping PickUp C

The Transfer Coping PickUp C is to hand-tighten with the captive screw using the Friadent Hex Driver 1.22 mm.

Impression taking

Perforate the tray to accept the PickUp Screw. Apply the impression material around the Transfer Coping PickUp C. Place the tray, filled with the impression material, and take the impression.

Once the material has set, loosen the screw and remove the impression. The Transfer Coping PickUp C remains in the impression without repositioning.

Reinserting of the Xive Gingiva Former C

Reposition the Xive Gingiva Former C after the impression is taken. This prevents the collapse of the created gingival emergence profile and protects the implant lumen.

Step-by-step: The repositioning technique on abutment level, closed tray

The correct transfer of the clinical situation to the master model is the prerequisite for a tension-free, precise fit of the prosthetic restoration.

After the completion of osseointegration and soft tissue contouring, the Friadent MP Abutment allows for taking impressions on gingiva, respectively abutment level, without removal of the Friadent MP Inserts and the MP Insert Screw.

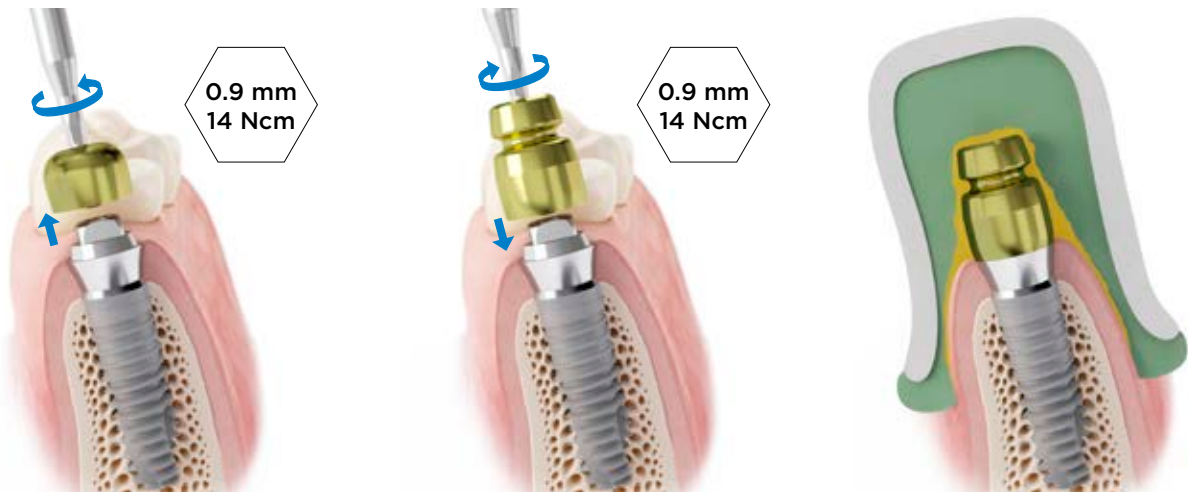

Removing the Friadent MP Cover Screw

Use the Hex Driver 0.9 mm to remove the Friadent MP Cover Screw. The MP Insert and the MP Insert Screw remain in the implant since impression taking is performed supragingivally.

Inserting the Friadent MP Transfer Impression Coping

Screw the Friadent MP Transfer Impression Coping onto the MP abutment by using the Hex Driver 0.9 mm.

Impression taking

Prior to taking the impression, seal the screw access hole with wax to prevent the ingress of the impression material.

Apply the impression material around the Transfer Coping. Place the tray, filled with the impression material, and make the impression. After the impression material has set, remove the tray.

Seal the MP abutment again with the Friadent MP Cover Screw until the final restoration is delivered.

Step-by-step: The PickUp technique on abutment level, open tray

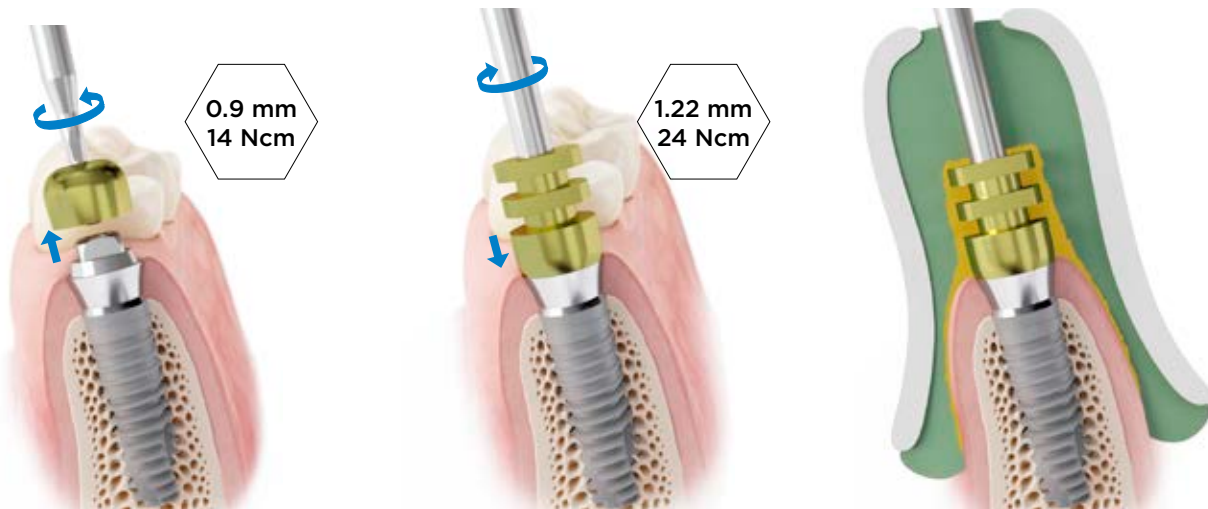

Removing the Friadent MP Cover Screw

Use the Hex Driver 0.9 mm to remove the Friadent MP Cover Screw. The MP Insert and the MP Insert Screw remain in the implant since the impression taking is performed supragingivally.

Inserting the Friadent MP PickUp Impression Coping

Position the Friadent MP PickUp Impression Coping on the MP abutment and tighten it with the MP PickUp Guide Pin using the Hex Driver 1.22 mm.

Impression taking

Perforate the tray to accept the PickUp Guide Pin. Apply the impression material around the MP PickUp Impression Coping. Place the tray, filled with the impression material, and make the impression.

After the impression material has set, unscrew the PickUp Guide Pin to remove the tray. The MP PickUp Impression Coping will remain in the impression. Seal the MP Abutment again with the Friadent MP Cover Screw until the final restoration is delivered.

Step-by-step: Impressions for CAD/CAM restorations

A precise master cast manufactured by the dental laboratory that reproduces the clinical situation is crucial for the precise fit of an Atlantis implant suprastructure.

The procedure described below includes several treatment sequences and is conducted in close collaboration with the dental laboratory.

Atlantis implant suprastructures: patient-specific bridges and bar-supported dentures

Patient-specific Atlantis implant suprastructures for Xive are always fabricated on abutment level and fixed with an occlusal screw.

During the one-stage/direct prosthetic procedure, MP Abutments remain in the patient's mouth. Using the two-stage/indirect prosthetic procedure, the MP Abutments, corresponding to the gingival height, are selected in the dental laboratory. They are delivered to the patient with the final prosthetic restoration.

Atlantis implant suprastructures are available in titanium and cobalt-chrome.



First appointment: Impression taking for the situation model

After removing the gingiva-forming components and, if given, delivery of the Friadent MP Abutments, take an impression using the PickUp technique with the PickUp Impression Copings (see page 41).

If you are using Friadent MP Abutments, seal them with Friadent MP Cover Screws until the next stage. Otherwise, reposition the abutments with corresponding gingiva-forming components (see page 15).

Send the impression to the laboratory.

In the dental laboratory: Fabrication of the situation model, individual tray and primary splint

Make a situation model from the impression. Fabricate a customized tray for the PickUp technique based on this model. Ensure there is adequate space for the impression material when the tray is made.

Use Friadent MP Impression Copings for the fabrication of the primary splinting. Divide the autopolymer splint (e.g., Integrity, Dentsply DeTrey) into individual segments and send it to the clinician for making the intraoral splinting and taking the impression.

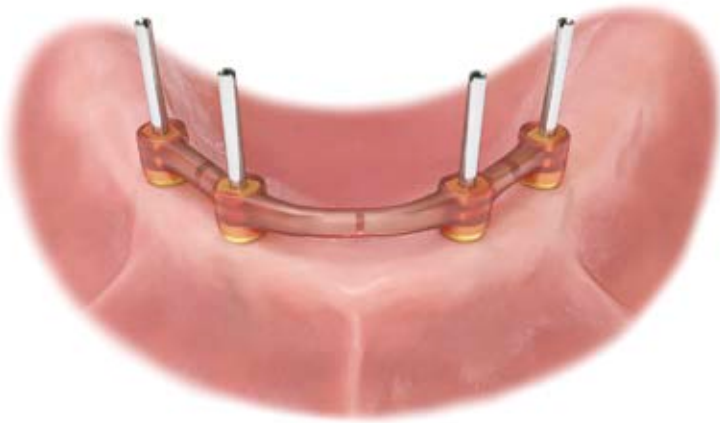

**Second appointment:
Intraoral splinting of the synthetic
elements**

Remove the gingiva-forming components and, if required, insert the Friadent MP Impression Copings. Attach the individual synthetic segments for the primary splint to the MP impression copings using the corresponding abutment screws. Ensure that there is adequate space between the individual segments. Trim the synthetic material where there is contact.

Splint the tension-free synthetic segments intraorally with the same autopolymer used by the laboratory.

Splint impression

Take the impression over the splinted retention caps using the impression material (i.e., Aquasil Ultra, Dentsply DeTrey) and the customized tray. After the dental impression material has set, remove the abutment screws and tray.

Send this final impression, including the retention caps, to the laboratory for fabricating the master cast.

Step-by-step: Impressions for CAD/CAM restorations

The laboratory will fabricate the master cast and the wax mock-up of the intraorally splinted situation from the second impression.



In the dental laboratory: Prepare the wax-up and transfer key

After completing the master cast, make a wax mock-up with tailored teeth.

Make a second transfer key from the autopolymer (e.g., Integrity, Dentsply DeTrey) in order to be able to compare the implant position in the master cast with the clinical situation. Splint the key in the laboratory.

Send components to the clinician for the try-in.

Third appointment: Try-in of wax-up

Try-in the wax mock-up with the tailored teeth made by the laboratory in respect to function and esthetics. Correct if necessary.

Sheffield Test

The Sheffield Test facilitates a simple check of the fit of a primary splinted mesiostructure on implants. After the structure has been positioned, each fixation screw is tightened separately while the other screws are not screwed in. Thus, the structure is only attached to one implant at a time.



If the framework is tension-free, the entire structure will rest on all of the implants when one screw is tightened.



If the structure is not tension-free, a gap will be formed between the implants and the part of the structure that is not screwed in.

Sheffield Test

Attach the autopolymer transfer key to the implants. Check the tension-free fit of the transfer key with fixation screws, which are each separately tightened in sequence (see the Sheffield Test on the right).

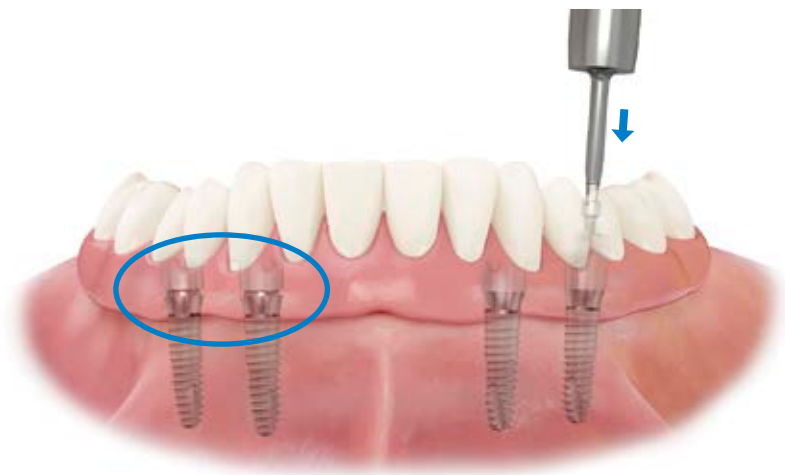

Restorations with Xive[®] S implants

Single tooth crowns

For the replacement of single missing teeth by implant-supported single crowns, the Xive system offers a wide range of pre-fabricated and patient-specific prosthetic options. These can be used to manufacture naturally esthetic restorations for the long-term maintenance of peri-implant hard and soft tissues.



Restorations with Friadent EstheticBase

The Friadent EstheticBase Abutment with pre-fabricated screw holes for horizontal or transverse screws can be customized and has an anatomically contoured shoulder, available in various gingival heights. This abutment can be used to fabricate both cement-retained and laterally screw-retained single crowns.

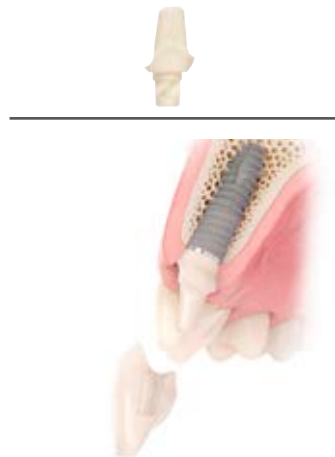

Restorations with Friadent Cercon

The Friadent Cercon Abutment allow for all-ceramic reconstructions meeting the highest esthetic demands in the anterior region.

All-ceramic single tooth restorations on Cercon Abutments must always be cemented.

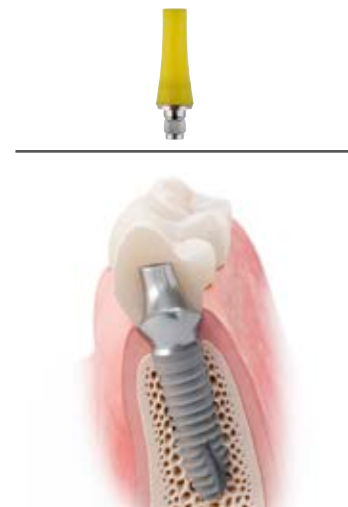

Restorations with Friadent AuroBase

The Friadent AuroBase Abutment serves as the basis for fabrication of individual crown abutments as well as of cement-retained or individually screw-retained crowns. The castable plastic cylinder enables almost unlimited individuality in the design of the abutment.



Restorations with Xive TitaniumBase

Xive TitaniumBase combines the proven strength of a prefabricated titanium abutment with the esthetics of an individually designed ceramic component.

This solution allows the dental laboratory to design and manufacture a CAD/CAM restoration within their preferred workflow.



Restorations with patient-specific Atlantis abutments

Atlantis abutments enable patient-specific cement-retained (Atlantis Abutments) and single tooth screw-retained (Atlantis Crown Abutment) restorations in the anterior and posterior region and represent an excellent base for the best possible results in both function and esthetics.



Restorations with patient-specific Atlantis abutments

Step-by-step: Xive® Platform-Switch concept

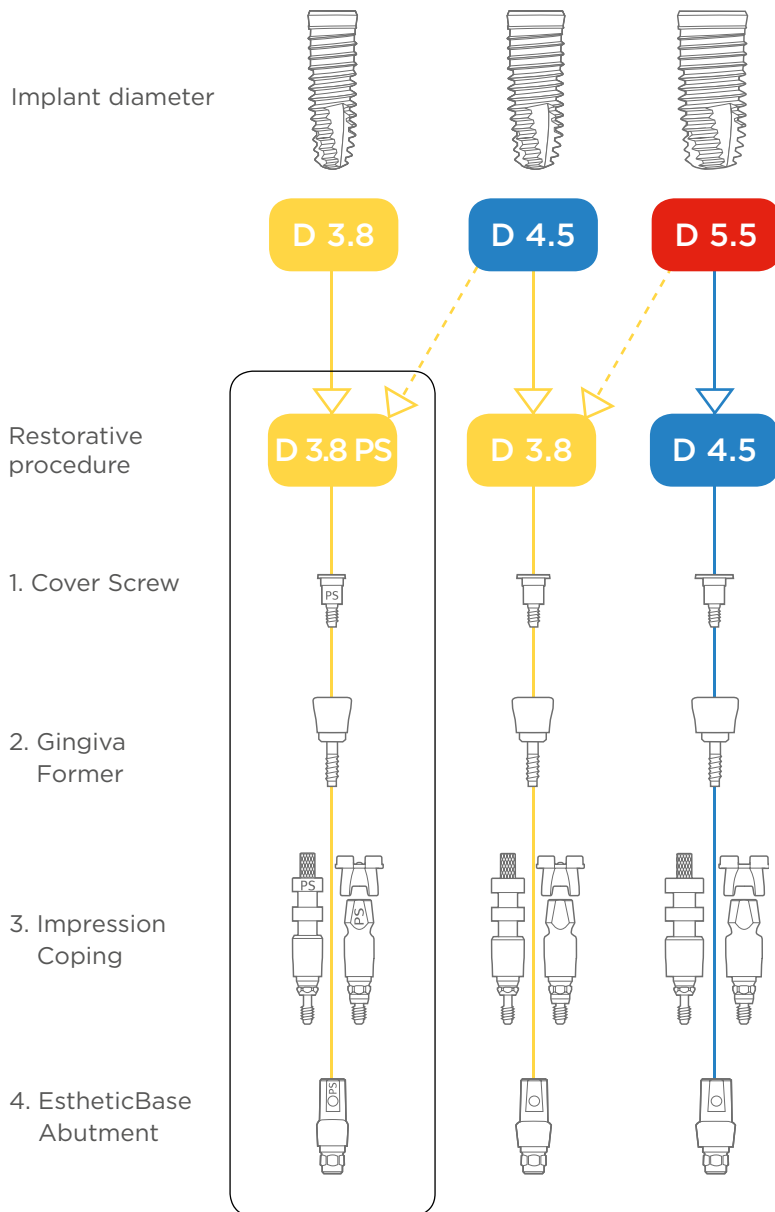

Example: Using special PS prosthetic components for D 3.8 implants



Removing the TempBase/ submerged healing

Xive implants are always supplied with the matching diameter Friadent TempBase. If submerged healing is planned, unscrew the TempBase retaining screw with the Hex Screw-driver 0.9 mm and remove it. Then, place the Xive Cover Screw PS D 3.8 and tighten at max. 14 Ncm. Continue with wound closure.

This procedure is also applicable for the D 4.5 and D 5.5 implant diameters. Observe the respective use of the appropriate diameter-reduced abutments. The Platform-Switch components are intended for use with Xive implants only.

Gaining soft tissue through platform-switching

For successful restorations with Xive platform-switching, it is essential to use not only the final abutment at a reduced diameter, but also to start with a diameter-reduced Cover Screw and to continue

with the appropriate prosthetic components. The platform-switching concept is designed to increase the soft tissue volume, which contributes to long-term esthetic outcomes.

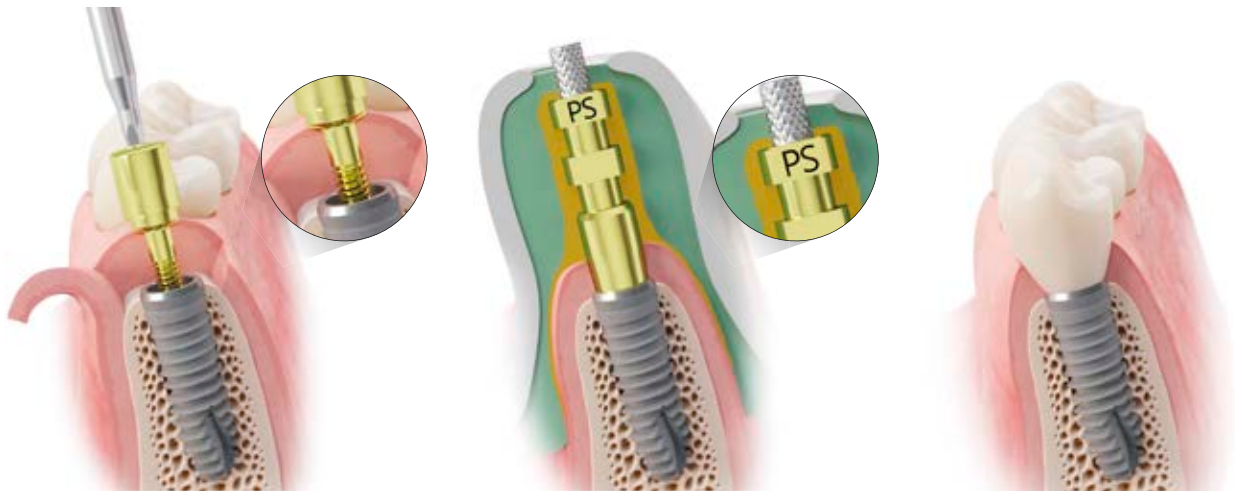

Placing the Xive Gingiva Former PS C (slim)

For transgingival healing place a Xive Gingiva Former PS C (slim) corresponding to the thickness of the soft tissue and hand-tighten with a 1.22 mm Hex Driver.

Impression taking using the PickUp technique

Precise transfer of the implant position is achieved with special PS components. For the PickUp technique, use the Xive Transfer Coping PickUp PS C. The Xive Transfer Coping PS C is available for the repositioning technique.

Final restoration

For the final restoration remove the Gingiva Former or temporary abutment and install the final abutment and crown, fabricated in the dental laboratory.

Consistent use of PS components centralizes the implant-abutment connection, creating an improved emergence profile.

Friident® EstheticBase



Dr. Marco Degidi, Bologna/Italy

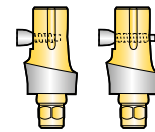

Horizontal and transverse screw

Friident EstheticBase Abutment

Friident EstheticBase Abutments are used to fabricate horizontally or transversally screw-retained or cement-retained single crowns.

The crown abutment also serves as the transition between the contour of the implant and the anatomical form of the restoration and thus has impact on the shape of the interdental space.

Pre-fabricated Friident EstheticBase Abutments are made of titanium and are available for implant diameters D 3.0 – D 5.5. They can be customized by grinding.



Xive EstheticBase PS straight (left) and Friadent EstheticBases straight



Xive EstheticBase PS angled (left) and Friadent EstheticBases angled



Friadent Horizontal and Transverse Screws Standard, Friadent Screw for EstheticBase



Friadent Horizontal and Transverse Screws Long, Friadent Horizontal Screw Seat

Friadent EstheticBase Abutments are available in 0° (straight) or 15° (angled) angulations to the implant axis. The abutments are made from titanium grade 2 and titanium alloy (Ti6Al4V grade 5).

Above the implant connection, an anatomically shaped preparation margin of the respective gingival height (1, 2, 3 or 5 mm) surrounds the abutment.

Horizontal screws

- For fixation of the crown in the oral abutment wall
- Available in lengths “standard” or “long”
- Available with or without the horizontal screw seat ring. The horizontal screw seat ring is used in the dental laboratory for casting high gold content precious metal alloys
- Tighten with Friadent Hex Driver 0.9 mm/14 Ncm
- Made from titanium alloy grade 5, Ti6Al4V

Transverse screws

- For fixation of the crown in both the oral and the vestibular abutment wall
- Double threading length for optimal stability
- With D 3.0 and D 3.4, the horizontal screw is used as a transverse screw
- Tighten with Friadent Hex Driver 0.9 mm/14 Ncm
- Made from titanium alloy grade 5, Ti6Al4V

Step-by-step: Friadent® EstheticBase Abutment

The fabrication of both cement-retained and laterally screw-retained crowns and bridges is possible on Friadent EstheticBase Abutments.

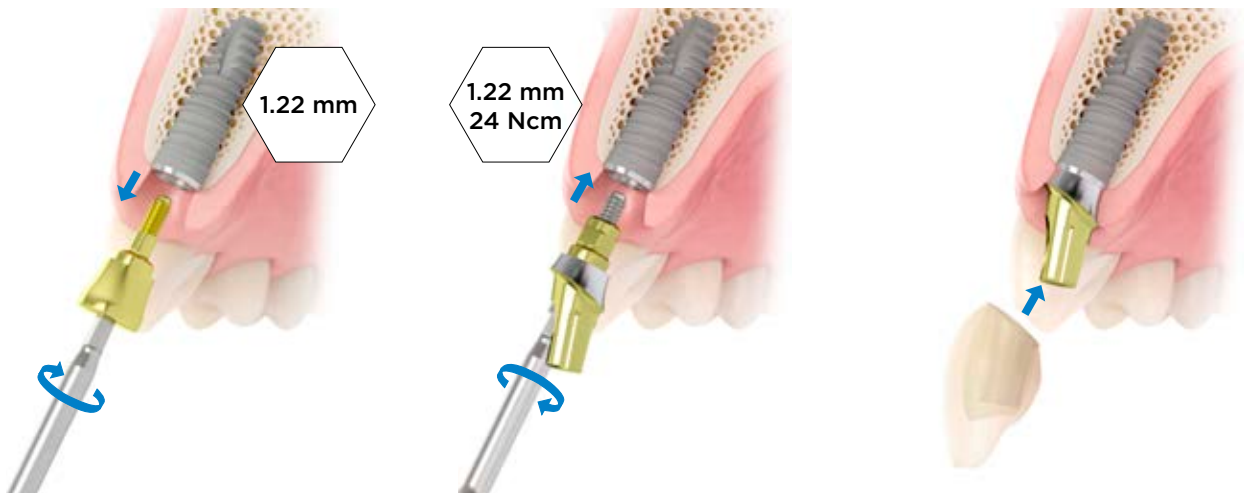

Removing the Xive Gingiva Former C

Use the Hex Driver 1.22 mm to unscrew the gingiva former.

Placing the EstheticBase Abutment

Place the EstheticBase Abutment in the implant according to the index position as determined in the model. The EstheticBase is to tighten with the abutment screw at 24 Ncm using the prosthetic ratchet and the Friadent Ratchet Hex Driver 1.22 mm or a torque-controlled contra-angle handpiece with the respective driver insert.

Mounting the superstructure

Check the fit of the crown on the abutment. Clean and disinfect the superstructure. The superstructure can be cement-retained as well as horizontally or transversally screw-retained.

For the manufacture of bridge constructions, the same procedure is used as for single crowns. Bridge constructions on EstheticBase Abutments can be cemented or screw-retained.



An alternative procedure

An alternative procedure



Cementing the superstructure

Phosphate cements can be used for cementing. When doing so, take care to completely remove the excess cement at the crown margins. When cementing with temporary cement, the upper two-thirds of the abutment have to be roughened.

Screwing in the superstructure horizontally

With horizontal screwing, the superstructure is secured in the oral abutment wall. Horizontal screws are available in standard or long lengths.

Tighten the horizontal screw with the Friadent Hex Driver 0.9 mm to the recommended torque of 14 Ncm.

Screwing in the superstructure transversally

With transversal screwing, the super-structure is secured in both the oral and vestibular abutment wall. Transverse screws have double threading length to ensure optimal stability. With D 3.0 and D 3.4, the horizontal screw is used as a transverse screw.

The use of the transversal screw with a long head is recommended for molars since the crown usually requires wider contouring. Tighten the transversal screw with the Friadent Hex Driver 0.9 mm to the recommended torque of 14 Ncm.

Friadent® Cercon®

Friadent Cercon Abutments allow for all-ceramic reconstructions meeting the highest esthetic demands in the anterior region. They offer superior esthetics through brilliant light dynamics. Made from zirconium dioxide ceramics, Cercon Abutments are extremely

stable. They are available in both, straight and angled versions. Friadent Cercon Abutments can be customized by grinding or firing. They are available in two shades of white.



Dr. Marco Degidi, Bologna/Italy

All-ceramic abutments

For situations where the mucosa thickness is less than 2.0 mm, pre-fabricated Cercon or CeraBase ceramic abutments are an esthetic solution.

Friadent Cercon Abutments

- One-piece, pre-fabricated from zirconium dioxide, thus extremely stable
- Available for diameters D 3.8 and D 4.5
- Gingival heights of GH 1 and GH 2
- Angulations from 0° (straight) to 15° (angled)

- Available in neutral white or dentin-colored
- For grinding to perform with cooling irrigation
- For tightening with Friadent Hex Driver 1.22 mm/24 Ncm

For customizing in the dental laboratory, the “ceramic line” grinding set from DeguDent is recommended.

All-ceramic crowns or crowns with ceramic shoulders should be cement-retained in all cases. The indication for ceramic abutments is limited to the anterior region.

Step-by-step: Friadent[®] Cercon[®] Abutment



Removing the Xive Gingiva Former C

Use the Hex Driver 1.22 mm to unscrew the gingiva former.

Placing the Cercon Abutment

Place the Friadent Cercon Abutment in the implant in the same indexed position as determined in the model. The Cercon Abutment is to tighten with the abutment screw at 24 Ncm using the prosthetic ratchet and the Friadent Ratchet Hex Driver 1.22 mm or a torque-controlled contra-angle handpiece with the respective driver insert.

Cementing the superstructure

Check the fit of the crown on the abutment. Clean and disinfect the superstructure. Phosphate cements can be used for cementing. When doing so, take care to remove the excess cement completely from the crown margins.

Friident® CeraBase

Two-piece, pre-fabricated Friident CeraBase ceramic abutments meet all the demands for an esthetic restoration. Single crowns, especially all-ceramic restorations in the anterior region, can be fabricated.



Friident CeraBase

The Friident CeraBase can be used to support exceptionally aesthetic single crowns in the anterior region of the maxilla and mandible. It is ideal for cases with very thin soft tissues. The Friident CeraBase can be used in straight abutment situations and slightly angled cases.

The Friident CeraBase Abutment for implant diameters D 3.4 – D 5.5 mm consists of two pieces: the titanium insert and the ceramic sleeve. The abutments are available in either wide or anatomical shape.

The pre-fabricated ceramic abutment enables the fabrication of esthetic all-ceramic single crowns of high quality, using both indirect and direct processing.

With indirect processing, the tooth-colored post, on which an all-ceramic crown is cemented, is prepared from the ceramic sleeve in the dental laboratory.

With direct processing for cement-retained or occlusally screw-retained single crowns, the laboratory directly veneers the ceramic sleeve with the appropriate ceramic and adheres it to the titanium core.

Step-by-step: Friadent® CeraBase Abutment

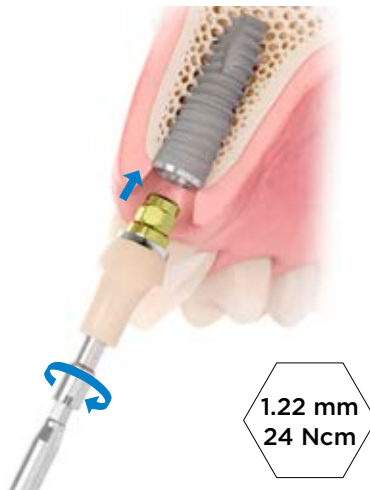

The dental laboratory procedure

The ceramic sleeve is customized according to the anatomical shape of the tooth and veneered directly or prepared for the fabrication of an all-ceramic crown.

Placing the Friadent CeraBase Abutment

Place the customized Friadent CeraBase Abutment in the implant in the same indexed position as determined in the model.

The Friadent CeraBase is to tighten with the abutment screw at 24 Ncm using the prosthetic ratchet and the Friadent Ratchet Hex Driver 1.22 mm or a torque-controlled contra-angle handpiece with the respective driver insert.

Delivery of the final prosthetic

Check the fit of the crown on the abutment. Clean and disinfect the superstructure. Block-out the top of the abutment screw and cement the crown onto the Friadent CeraBase. Carefully remove all excess cement.

In case of correct axial position of the implant, the CeraBase Abutment can alternatively be directly veneered for an occlusally screw-retained restoration.

In this case, after removing the Gingiva Former, the final crown is to tighten with the abutment screw at 24 Ncm using the prosthetic ratchet and the Friadent Ratchet Hex Driver 1.22 mm or a torque-controlled contra-angle handpiece.

Step-by-step: Friadent® AuroBase Abutments

The one-piece Friadent AuroBase Abutment serves as the basis for the fabrication of individual crown abutments for cement-retained or individual screw-retained crowns. The pre-fabricated castable abutment allows for almost unlimited individuality in the design of the abutment.



Friadent AuroBase D 3.0 with Standard Abutment Screw D 3.0 (left)
Friadent AuroBase D 3.4 - D 5.5 with Standard Abutment Screw



Friadent AuroBase

Special indications for the Friadent AuroBase are the correction of large axial divergences, the fabrication of occlusal screw-retained single crowns and of primary parts for telescopic or conical crown technique.

- Available in D 3.0 - D 5.5, including the corresponding abutment screw
- 14 mm high modeling cylinder made of POM resin
- Pre-fabricated HSL basis of castable precious metal alloy
- 3.4 mm deep, internal hexagon implant-abutment connection providing the anti-rotation lock between abutment and implant

For bridge restorations, the same procedure is used as for single crowns.

The dental laboratory procedure

Place the Friadent AuroBase on the master cast and customize according to the anatomical situation.

Wax up the crown framework and form individual gingiva margins corresponding to the planned prosthetic restoration (for detailed information, please refer to instructions for use).

When processing the AuroBase abutments, Friadent Milling Anagols should always be used for completing the master cast.



An alternative procedure



1.22 mm
24 Ncm



0.9 mm
14 Ncm

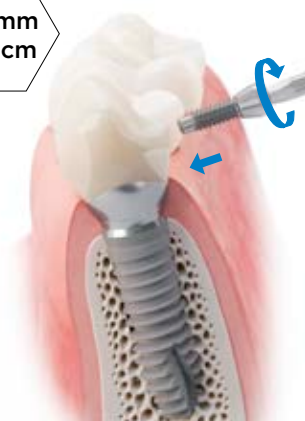

Placing the Friadent AuroBase Abutment

Place the individual AuroBase Abutment into the implant in the same position as determined in the model. The AuroBase Abutment is to be tightened with the abutment screw at 24 Ncm using the prosthetic ratchet and the Friadent Ratchet Hex Driver 1.22 mm or a torque-controlled contra-angle handpiece with the respective driver insert.

Cementing the superstructure

Check the fit of the crown on the abutment. Clean and disinfect the superstructure.

Phosphate cements can usually be used for cementing. When doing so, take care to remove the excess cement completely from the crown margins.

When cementing with temporary cements, the upper two-thirds of the abutment should be roughened or blasted.

Screwing in the superstructure

Tighten the veneered AuroBase occlusally in the implant using the Hex Driver 1.22 mm with a torque of 24 Ncm.

With horizontal screw retention (anterior region), use the Hex Driver 0.9 mm to fix the crown on the AuroBase abutment with a torque of 14 Ncm.

Xive® TitaniumBase

For your preferred workflow – Xive TitaniumBase combines the proven strength of a prefabricated titanium abutment with the esthetics of an individually designed ceramic component.

This solution allows the dental laboratory to design and manufacture a CAD/CAM restoration within their preferred workflow.



A precision manufactured component

TitaniumBase for Xive is manufactured with the highest precision, meeting the requirements of the Bone-care with platform-switch connection – one of the four interdependent features of the well-documented Xive system.

Note: Xive TitaniumBase Abutments are not compatible with Frialit implants in diameters D 4.5 and D 5.5.

Individually designed for esthetic results

The ceramic component is designed and manufactured with the ideal emergence profile and shape according to the preferred workflow of the dental laboratory. The extra-oral gluing process gives full control of the procedure, and any adhesive residue can be easily removed.

Deep internal hex connection with high precision

An important feature of the subgingival Xive implant is the deep internal hex implant-abutment connection. The precise hexagon facilitates placement of the abutments in six defined positions and provides for an anti-rotation lock between abutment and implant. With parallel walls above and below the hex, the internal connection extends over a total length of approximately 3.5 mm. This provides high stability and minimizes micromovement between the implant and the abutment.

Atlantis® patient-specific abutments

Using Atlantis patient-specific abutments that go beyond CAD/CAM, offers the optimal foundation for the greatest degree of individuality on Xive implants.

Atlantis abutments support cement-retained and single tooth screw-retained restorations and represent an excellent base for the best possible results in both function and esthetics.



Greatest possible flexibility and precision

With Atlantis abutments, all necessary design parameters are taken into consideration, which makes outstanding prosthetic restorations possible. With the patented Atlantis VAD (Virtual Atlantis Design) software, each Atlantis abutment is individually designed based on the final tooth shape, taking into consideration the specific edentulous space, the adjacent teeth and the anatomy of the soft tissue.

Optimized soft tissue management

The emergence profile of Atlantis abutments can be individually designed and therefore used for soft tissue contouring.

No adjustments necessary

The precise connection of Atlantis abutments for Xive provides a strong and stable fit and optimal load transfer. Atlantis patient-specific abutments also eliminate the need for chairside modification.

Atlantis Abutments for cement-retained restorations

The Atlantis Abutment is available in titanium, gold-shaded titanium or zirconia. The zirconia abutments are delivered in different shades.

Atlantis Crown Abutments for screw-retained restorations

Atlantis Crown Abutments are available in titanium and five shade of zirconia, including a translucent option in white.

It is an efficient, effective and esthetic alternative to traditional cast abutments for single tooth screw-retained restorations with porcelain or composite applied directly to the abutment.

Step-by-step: Xive® TitaniumBase Abutment

The customizable Xive TitaniumBase Abutment enables the dental technician to manufacture esthetic, high-quality ceramic abutments with a titanium core.

These allow for fabrication of patient-specific restorations which come as close as possible to the natural esthetics in both the anterior and posterior region.

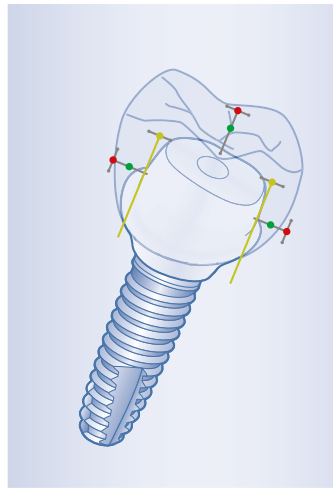
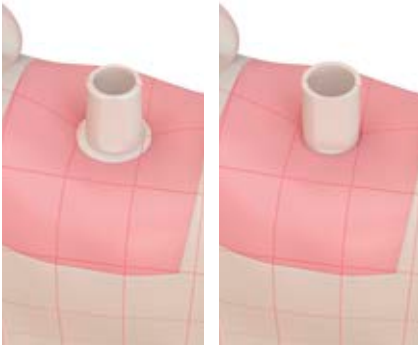

Impression taking and the scanning procedure

Expose the implants in case of submerged healing. Remove the Cover Screw or gingiva-forming components using the Hex Driver and take impressions as described starting on page 36. Mount/remount the Gingiva Former after impression taking. The laboratory receives the impression for casting the model.

In the dental laboratory, the model is scanned with/without the mounted scan post (ScanBase). Use scanspray for gingival masks to ensure an accurate scan. For restorations with more than four teeth, an additional wax-up scan should be made.

Design

Design the ceramic part according to anatomical preferences. The finished CAD-designed customized abutment with the virtual TitaniumBase can now be manufactured. The fine tuning of the abutment design should be based on the preparation guidelines for natural teeth as well as on the guidelines for the materials being used.

The created STL data set, the basis for the fabrication of the individual mesostructure, can either be locally milled or sent to any desired dental milling facility.

Fixation of the TitaniumBase

After blasting with aluminum oxide and pre-treating with a metal primer, the TitaniumBase is to bond with the individually milled ceramic abutment with a suitable adhesive, according to the instructions of the adhesive manufacturer. For optimal positioning, the fabrication of a transfer key is recommended.



An alternative procedure



Placing the TitaniumBase Abutment

Place the individual TitaniumBase Abutment in the implant with the index position as determined in the model.

The TitaniumBase Abutment is to tighten with the abutment screw at 24 Ncm using the prosthetic ratchet and the Friadent Ratchet Hex Driver 1.22 mm or a torque-controlled contra-angle handpiece with the respective driver insert.

Final restoration

Place the final zirconia crown on the individual TitaniumBase Abutment and cement it intraorally. When doing so, take care to remove excess cement completely from the crown margins.

For the manufacture of bridge constructions, the same procedure is used as for single crowns.

Xive TitaniumBase screw-retained crown

Alternatively, the full contour crown or veneered crown can be produced and bonded onto the TitaniumBase for the single tooth screw-retained restoration.

In this case, after removing the Gingiva Former, the final crown is to tighten with the abutment screw at 24 Ncm using the prosthetic ratchet and the Friadent Ratchet Hex Driver 1.22 mm or a torque-controlled contra-angle handpiece with the respective driver insert.

Step-by-step: Atlantis[®] patient-specific abutments

Atlantis patient-specific abutments are available in biocompatible materials including titanium, gold-shaded titanium (titanium nitride coated - TiN) and different shades of zirconia for esthetically demanding cases.

Atlantis VAD (Virtual Abutment Design) is an expert system software that designs abutments entirely in a virtual environment. It's smart software that can take all of the information input and transform it into an initial abutment design.

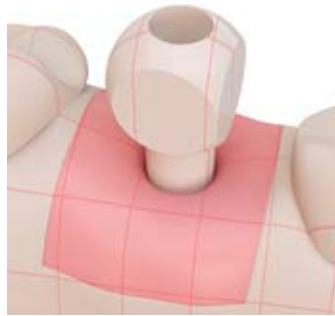

Dental practice

Take a digital implant-level impression with an intraoral scanner and Atlantis IO FLO. Analyze the digital file and transmit the file to the dental laboratory with a request for an Atlantis Abutment.

As an alternative, take a precise traditional implant-level impression (e.g., Aquasil Ultra, Dentsply DeTrey) and send the materials to your dental laboratory with a request for an Atlantis Abutment.

Dental laboratory

Review the digital file or use the traditional impression to create the master cast, including a gingiva mask. Either scan the master cast at the dental laboratory or send it to the Dentsply Implants production facility. Submit the order in Atlantis WebOrder for design and production.

Abutment design

The Atlantis Abutment is designed at Dentsply Implants, using the Atlantis VAD software. The software makes it possible to design each abutment in relation to the edentulous space and the surrounding teeth.

The abutment design can be reviewed and approved by the dental technician in Atlantis 3D Editor before production.



An alternative procedure

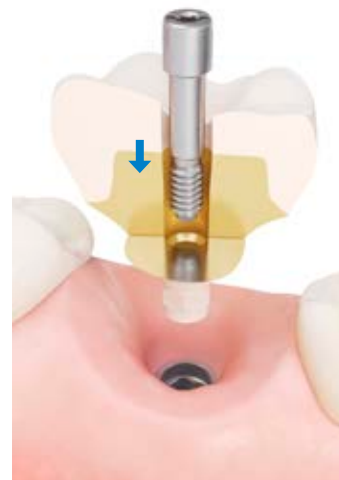
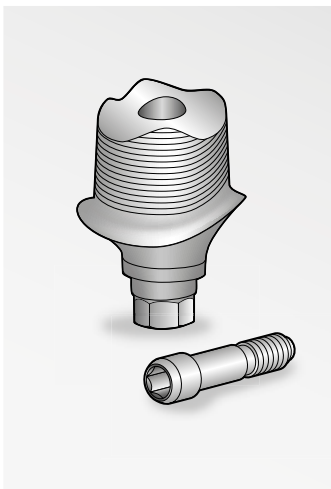

Final restoration

The Atlantis Abutment with the abutment screw is delivered to the clinician.

Additional modification of the Atlantis Abutment is not recommended.

Abutment installation

The Abutment is to tighten with the abutment screw at 24 Ncm using the prosthetic ratchet and the Friadent Ratchet Hex Driver 1.22 mm or a torque-controlled contra-angle handpiece with the respective driver insert.

Clean and disinfect all components. Metal crowns can be cement-retained or screw-retained. All-ceramic crowns or crowns with a ceramic shoulder should always be cemented.

Atlantis Crown Abutment

The Atlantis Crown Abutment is indicated for single tooth, screw-retained restorations. It is an efficient, effective and esthetic alternative to traditional cast abutments. Porcelain or composite can be applied directly onto the abutment and the abutment design supports the veneering material. The Atlantis Crown Abutment is available in titanium (grade 5) and in five shades of zirconia.

For more information, refer to the Design guide – Atlantis patient-specific abutments.

For the manufacture of bridge constructions, the same procedure is used as for single crowns. Bridge constructions on individual abutments can only be cemented.

Fixed solutions for larger tooth gaps and the edentulous jaw



Delivery of the prosthetic restoration on implant level

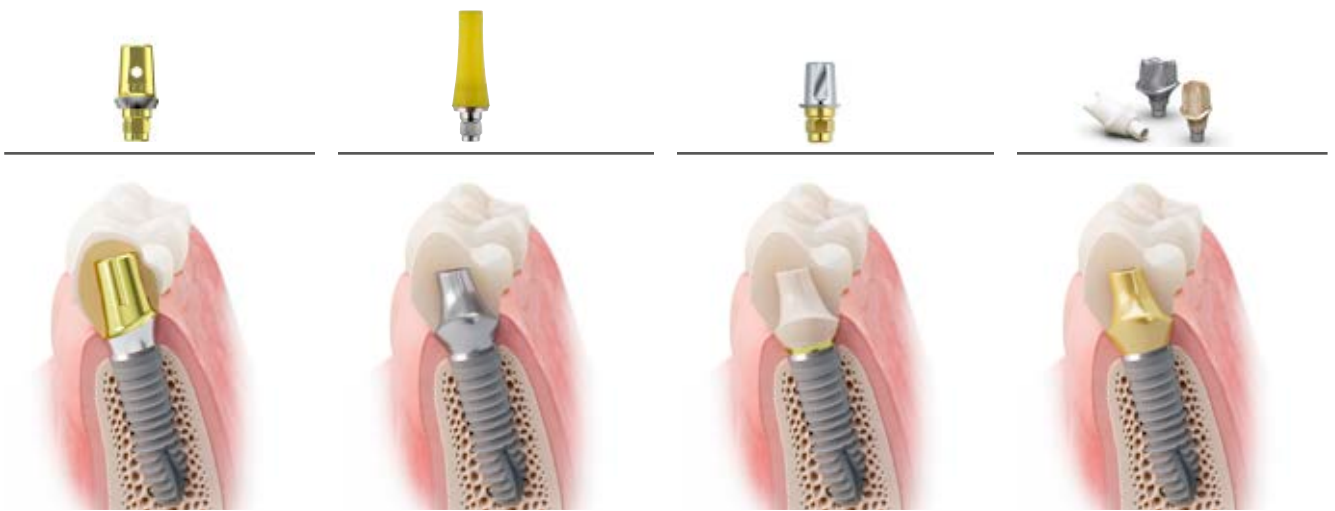

Restorations with Friadent EstheticBase

Friadent EstheticBase Abutments with pre-drilled holes for horizontal or transverse screws can be customized. They have an anatomically contoured shoulder, available in various gingival heights.

These abutments can be used to support both cement-retained and laterally screw-retained bridges.

Restorations with Friadent AuroBase

AuroBase Abutments with pre-fabricated implant connection serve as the basis for individual abutments, enabling almost unlimited individuality.

They can therefore be used for restoring cases pre-senting special challenges, such as large axial divergences or a small interocclusal clearance, with telescopic or conical crown technique.

Restorations with Xive TitaniumBase

Xive TitaniumBase combines the proven strength of a prefabricated titanium abutment with the esthetics of an individually designed ceramic component.

This solution allows the dental laboratory to design and manufacture a CAD/CAM restoration within their preferred workflow.

Restorations with patient-specific Atlantis abutments

Atlantis abutments enable patient-specific cement-retained (Atlantis Abutments) and single tooth screw-retained (Atlantis Crown Abutment) restorations in the anterior and posterior region and represents an excellent base for the best possible results in both, function and esthetics.

The WeldOne concept

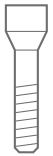

Delivery of the prosthetic restoration on abutment level

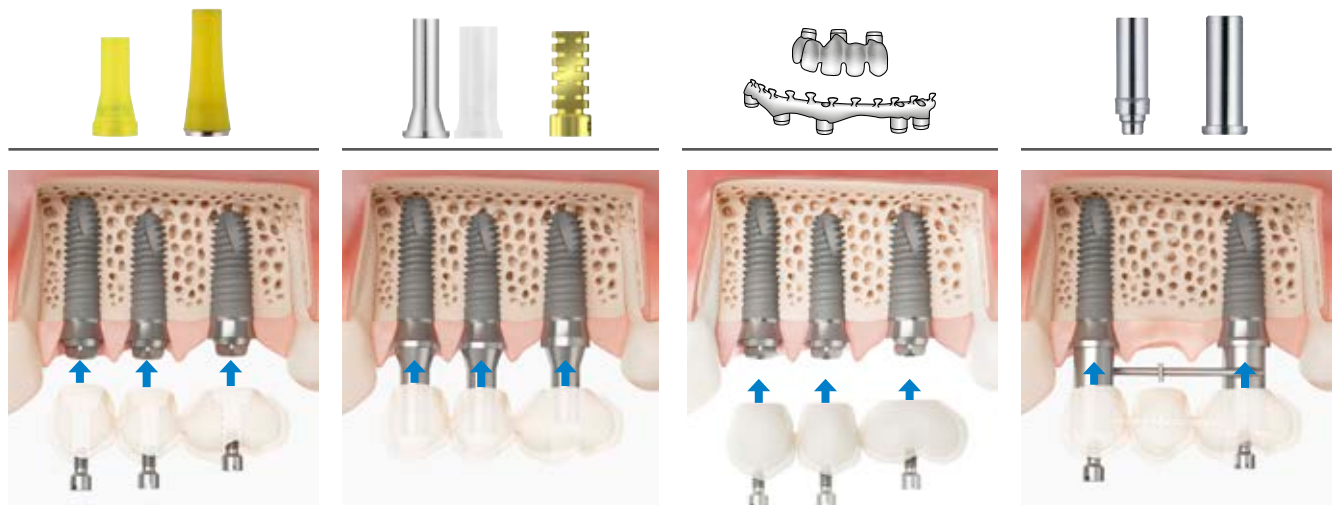

Restorations with Xive/Friadent MP Abutments: Castable/Cast-to Waxing Sleeve

Friadent Castable and Cast-to Waxing Sleeves are used to fabricate screw-retained bridges on Xive/Friadent MP Abutments.

Restorations with Xive/Friadent MP Abutments: PassivFit Set/Xive MP Retention Sleeves

The Friadent PassivFit Set consists of a titanium sleeve and a castable plastic sleeve. A pre-defined bonding gap enables intraoral bonding and thus a passive fit of the superstructure.

The MP Retention Sleeves are for polymerizing into prosthesis/bridges and impression taking (PickUp).

Restorations with Xive/Friadent MP Abutment and Atlantis supra-structures

The Atlantis bars, bridges or hybrids are the solution for partially edentulous and edentulous arches, meeting patient requirements and preferences for function and esthetics.

Restorations with the WeldOne concept

The WeldOne concept provides a stable, passive-fit framework for temporary prostheses for immediate restorations on the same day of surgery.

Xive®/Friadent® MP Abutments (Multi Purpose)

Friadent MP Abutments are used to support screw-retained bridges or bar constructions for restoring multiple implants. The prosthetic procedure can follow two different protocols: one-stage (direct) or two-stage (indirect).



Impression taking on abutment level with MP Transfer Impression Copings and sealing with Cover Screws



Color-coded MP Abutment Inserts (D 3.4 - 4.5) and MP Insert Screws. The number of grooves on the screw head indicates the gingival height of the matching Abutment Insert.

Xive MP Abutments angled, Xive MP Insert Head premounted on a seating instrument

Friadent MP Abutment straight/ Xive MP Abutment angled

The Friadent MP Abutment straight and the Xive MP Abutment angled are made from titanium. They are available in different diameters and gingival heights. For each gingival height of a straight MP Abutment, there is a matching MP Insert Screw to tighten the MP Abutment Insert in the implant.

The very small head of the angled Xive MP abutments provides optimum freedom of design of the superstructure with respect to height and diameter.

The short and flexible seating instrument ensures secure handling and simplified placement of the abutment, in particular when space is limited.

Xive MP Abutment PS (platform-switch)

- Enables the restoration of implants D 3.8 and D 4.5 with diameter-reduced abutments
- Platform-switch abutments favor long-term esthetic results
- All platform-switch abutments are laser-marked with "PS"

The SmartFix concept – The prosthetic solution on implants placed at an angle

The SmartFix concept allows for immediate restoration of edentulous patients with screw-retained bridges or bar dentures in the maxilla and mandible on a minimum of four implants.

To obtain a common path of insertion, the implants placed at an angle are provided with 15° or 30° angled Xive MP Abutments.

Two restorative options are available: Conventional superstructure fabrication or Atlantis implant suprastructures with a high precision fit.

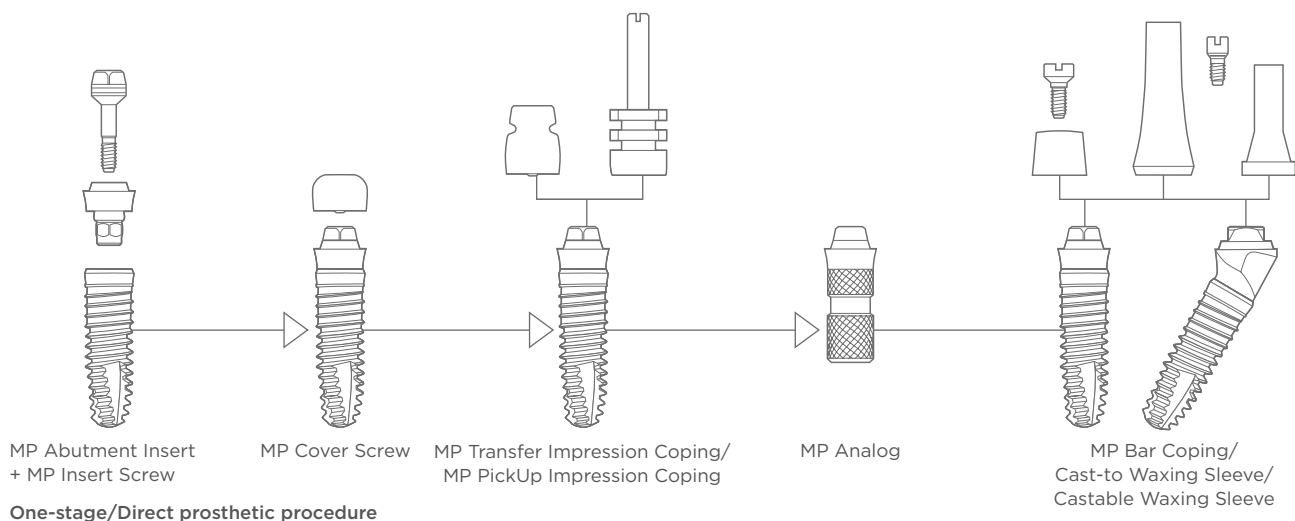

One-stage/ Direct prosthetic procedure

Two different prosthetic protocols can be followed for manufacturing restorations on MP Abutments:

- One stage (direct prosthetic procedure)
- Two stage (indirect prosthetic procedure)

With the direct procedure, MP abutments are installed directly after implant placement or at re-entry after submerged healing and remain in the patient's mouth, following the "one-abutment, one-time" principle.

The impression is taken on abutment level (see p. 42 for the step-by-step instructions on impression-taking) and the dental laboratory works on MP Analogs.

Two-stage/ Indirect prosthetic procedure

With the two-stage procedure, the impression is taken on implant level (see p. 36 for the step-by-step instructions on impression-taking).

The MP Abutments, corresponding to the gingival height, are selected in the dental laboratory. They are delivered to the patient with the final prosthetic restoration.

The SmartFix[®] concept

The SmartFix concept allows for immediate restoration of edentulous patients with screw-retained bridges or bar dentures in the maxilla and mandible on a minimum of four implants.

To obtain a common path of insertion, the implants placed at an angle are restored with 15° or 30° angled Xive MP Abutments.

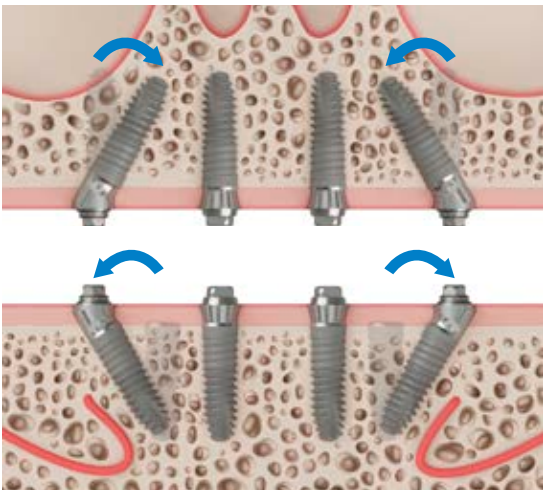

Avoiding the need for bone grafting

Augmentation and critical anatomical areas can be largely circumvented by using implants placed in an angled position. For example, this avoids sinus floor elevation in the maxilla or nerve transposition in the mandible.

Stable prosthetic fit

The area supporting the prosthesis is extended distally by anchoring the angled implants in existing bone volume. The local bone is thus utilized optimally and improves the support of the prostheses by reducing cantilevers.

Two fabrication options are available for the restorations: conventional superstructure fabrications or Atlantis implant suprastructures with a high precision fit.

The SmartFix concept offers the following advantages:

- Provides stable prosthetic fit
- Avoids critical anatomical areas by angled implant placement

Step-by-step: The SmartFix® concept

The two components of the angled MP abutments are pre-mounted on a seating instrument. The seating instrument is made of PEEK plastic and can be pre-

shaped outside the oral cavity, if required, to provide easier placement of the angled MP abutments in the implants.

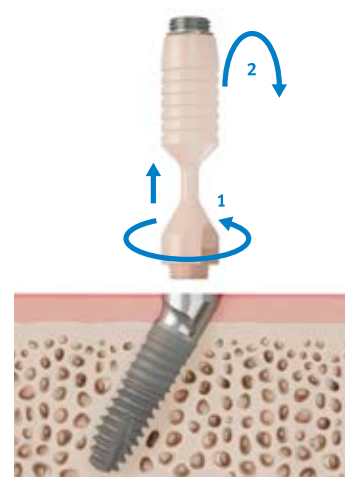
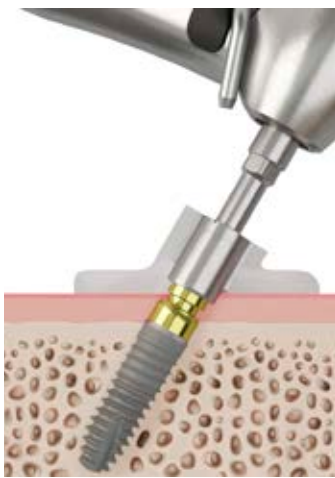

Implant placement

If necessary, insert the implants at an angle, whereby one marker on the implant driver must point in the direction of the implant apex. Axial divergences between two implants can be compensated up to 45°. Preferably, computer-guided pre-operative planning is conducted (i.e., with Simplant).

Further information is given in the appropriate surgical instruction manuals.

Placement of the angled prosthetic abutments

Position the abutment body of the angled MP Abutment in the implant using the seating instrument. The abutment platforms should be parallel to the occlusal plane. A Friadent Hex Driver with a 1.22 mm width is used for screw-tightening at a required torque of 24 Ncm.

If necessary, post-preparation of the surrounding bone may be required prior to delivery of the abutment. Check the final fit of the abutments via suitable radiographic imaging.

Unscrew seating instruments and reverse

Unscrew the seating instrument from the abutment body of the angled MP Abutment, rotating it to the left. Then, rotate the seating instrument through 180° to position the abutment head.

Step-by-step: The SmartFix[®] concept



Insertion of abutment heads and removal of seating instruments

Following final screw retention of the abutment body, use the seating instrument to hand-tighten the abutment head into the abutment body. Snap off and remove the seating instruments from the abutments.

Note: For easier alignment of the angled implants, leave the TempBase in the implants. The axis of the seating instrument can then be aligned to provide a common path of insertion.

Screw-tightening of insert heads and wound closure

Use the Friadent seating instrument for MP Insert Screw to screw in the abutment head at a torque of 24 Ncm. Seal the edges of the wound with monofilament sutures.

Impression taking with the PickUp technique

Transfer the abutment positions using the PickUp technique with MP PickUp impression copings in combination with MP PickUp guide pins.

Send the impression to the dental laboratory.

Notes on using the existing prosthesis:

- Place the MP Retention Sleeves and shorten if required
- Hollow-grind the prosthesis adequately
- Avoid misalignment of the MP Retention Sleeves
- Avoid excessive polymerization shrinkage
- Protect soft tissue by using a cofferdam curved incision
- Mix cold-cure polymer (such as Selecta plus, Dentsply) bubble-free and viscous
- Cover MP Retention Sleeves completely, let the screw hole accessible

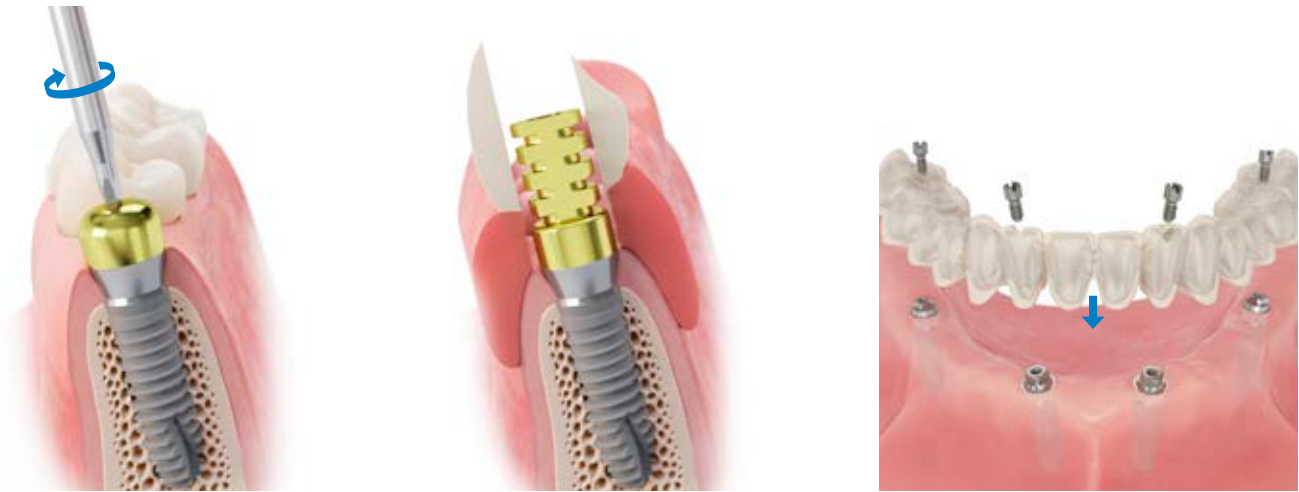

Sealing with Friadent MP Cover Screws

The angled MP abutments remain in the patient's mouth. Seal with MP Cover Screws until delivery of the prosthetic restoration.

Polymerizing into a prosthesis/bridge

The existing prosthesis can be modified to provide temporary restoration. To avoid misalignment of the MP Retention Sleeves in the prosthesis with resulting changes in occlusion, avoid any transverse and/or vertical displacement of the prosthesis during the polymerization process. Extended functional margins can be shortened as much as needed.

Screwing in the final superstructure

Clean and disinfect the superstructure and attach it to the MP Abutments with the screws received from the dental laboratory using a 1.22 mm hex screwdriver at a torque of 24 Ncm.

Friadent® Castable/Cast-to Waxing Sleeves

The Friadent Castable and Cast-to Waxing Sleeves are used as pre-fabricated wax-up bases for the fabrication of screw-retained as well as individually milled bridge and bar constructions on Friadent MP Abutments.



Friadent Castable Waxing Sleeve

Xive/Friadent MP Abutments in combination with Friadent Castable Waxing Sleeves are used to fabricate screw-retained bridge frameworks. Depending on the selected procedure (see p. 71), the MP Abutments are selected either chairside or in the laboratory. The waxing sleeves are always selected in the laboratory according to the respective MP Abutments. The dental technician shortens the waxing sleeve as required and uses it as the basis for the bridge framework. After casting, the mating surfaces of the framework must be smoothed with the Friadent Finishers.

Friadent Finisher

The Friadent Finishers, manufactured from stainless steel, are required for simple and exact smoothing of the mating surfaces and rough patches left by the casting process.

The Finisher for the Screw Head Seat ensures that the Friadent MP Screw for Castable Sleeve is correctly seated.

Friadent Cast-to Waxing Sleeve

The Cast-to Waxing Sleeve made from POM plastic is mounted on a gold cylinder of cast-to precious metal alloy with high melting point.

Friadent Cast-to Waxing Sleeves on MP Abutments are used to fabricate screw-retained bridges. Depending on the selected procedure (see p. 71), the MP Abutments are selected either chairside or in the laboratory. The respective Waxing Sleeves are always selected in the laboratory and can be shortened as required to be used as the base for the bridge framework.

Unlike the castable waxing sleeves, cast-to waxing sleeves do not require finishing with the Friadent Finishers.

Friadent® PassivFit Set/ Xive® MP Retention Sleeves



Friadent PassivFit Set

The Friadent PassivFit Set, consisting of a Friadent PassivFit Titanium Sleeve and a Friadent PassivFit Waxing Sleeve, is used for intraoral compensation of inaccuracies with the superstructure fit.

The Friadent PassivFit Titanium Sleeve serves as a pre-fabricated basis for the fixation of individual superstructures on Friadent MP Abutments.

The Friadent PassivFit Waxing Sleeve is used as a pre-fabricated modelation base for producing individual superstructures on PassivFit Titanium Sleeves.

- Only use adhesives approved for dental use. Avoid bonding gaps that are too large or too small.
- The wall thickness of the titanium sleeve meets dental technological requirements and is reinforced by the superstructure. Mechanical stability is determined by the design of the superstructure.
- Can also serve as a temporary restoration with plastic bridge.

Xive MP Retention Sleeves

- Polymerizing into a prosthesis/bridge
- Impression taking (pickup) on the abutment level
- Titanium Alloy (Grade 5)
- Color coded & laser tagged
- Short and long version

Step-by-step: MP Abutments with Castable/Cast-to Waxing Sleeves



Impression taking and the use of the waxing sleeve

Impressions can be taken either on the implant level (MP Abutments are selected by the laboratory) or on the abutment level (the model is cast on MP Analogs) using the respective impression copings (see p. 36 for the step-by-step instructions for impression taking).

The superstructure is fabricated in the dental laboratory using Castable or Cast-to-Waxing Sleeves. The instructions for use for Castable/Cast-to Sleeves are to be considered.



Fabrication of the superstructure

The bridge - or bar - construction is waxed-up, cast and, prior to delivery, polished with the intended finishers. No finishers are required when using the Cast-to-Waxing Sleeve.

Subsequently, the bridge is veneered. For detailed step-by-step instructions for the dental laboratory procedure, please refer to the Xive Laboratory Manual.



One-stage/ Direct prosthetic procedure

Using the Hex Driver 0.9 mm, remove the MP Cover Screws from the MP Abutments.

Ensure the tight fit of the MP Insert Screws or, for angled MP Abutments, the Insert Head, using a Hex Driver 1.22 mm at a torque of 24 Ncm.



An alternative procedure



Two-stage/ Indirect prosthetic procedure

Unscrew the gingiva-forming components using the Hex Driver 0.9 mm, or expose the implants and remove the Implant Cover Screws.

Then, place the MP Abutments and tighten them with the corresponding MP Insert Screws, using the Seating Instrument for the MP Insert Screw. The recommended torque for the MP Insert Screws is 24 Ncm.

Checking the fit

Prior to final completion, check the fit for correlation, esthetics, phonetics and bite conditions (Sheffield Test, see p. 47).

Placing the superstructure

For the final restoration, secure the superstructure with the Friident MP Screws for Castable Sleeves, using the Hex Driver 1.22 mm at a torque of 24 Ncm.

The same procedure is used for the manufacturing of constructions on Xive TG Implants. Please use the respective Xive TG components.

Step-by-step: MP Abutments with the PassivFit Set (intraorally cemented)



Impression-taking and using of the PassivFit Set

Impressions can be taken either on the implant level (MP Abutments are selected by the laboratory) or on the abutment level (the model is cast on MP Analogs) using the respective impression copings (see p. 36 for the step-by-step instructions for impression taking).

Place the titanium sleeves on the MP Abutments or MP Analogs, secure with Friadent MP Screws for Castable Sleeve and shorten individually. Slide the Plastic Sleeves onto the Titanium Sleeves and adjust them accordingly.

Fabrication of the superstructure

The bridge - or bar - construction is now waxed-up, cast and veneered, using the Plastic Sleeves. For detailed step-by-step instructions for the dental laboratory procedure, please refer to the Xive Laboratory Manual.

One-stage/ Direct prosthetic procedure

Using the Hex Driver 0.9 mm, remove the MP Cover Screws from the MP Abutments. Ensure the tight fit of the MP Insert Screws or, for angled MP Abutments, the Insert Head, using a Hex Driver 1.22 mm at a torque of 24 Ncm.



An alternative procedure



Two-stage/ Indirect prosthetic procedure

Unscrew the gingiva-forming components using the Hex Driver 0.9 mm, or expose the implants and remove the Implant Cover Screws.

Then, place the MP Abutments and tighten them with the corresponding MP Insert Screws, using the Seating Instrument for the MP Insert Screw. The recommended torque for the MP Insert Screws is 24 Ncm.

Placing the titanium sleeves

Place the customized titanium sleeves on the MP Abutments and tighten with Friadent MP Coping Screws using a Hex Driver 1.22 mm at a torque of 24 Ncm.

Placing the superstructure

Place the prosthetic restoration on the titanium sleeves and bond the framework intraorally. This helps compensate for any inaccuracies of fit of the superstructure.

The same procedure is used for the manufacturing of constructions on Xive TG Implants. Please use the respective Xive TG components.

Step-by-step: MP Abutments with Atlantis® Bridge and Hybrid

Atlantis implant suprastructures offer all options manufacturing patient-specific solutions for restoring partially- or fully-edentulous jaws on two or more implants on the implant or abutment level.

An Atlantis Bridge provides a reduced anatomical framework for optimal ceramic or composite layer techniques.

An Atlantis Hybrid structure provides additional retention elements. The restoration can be finished using plastic teeth and acrylic resin.



Impression taking and the dental laboratory procedure

Impressions can be taken either on the implant level (MP Abutments are selected by the dental laboratory) or on the abutment level (the model is cast on MP Analogs) using the respective impression copings (see p. 36 for the step-by-step instructions for impression taking).

At the dental laboratory, a soft-tissue mask and a silicone key are used to make a diagnostic tooth set-up, or a design template made of wax or plastic on the master model for the manufacture of the bridge or hybrid construction.

The order procedure

Framework orders are submitted through Atlantis WebOrder (www.Atlantisweborder.com). The master cast, and if applicable the MP analogs or MP abutments and the diagnostic tooth set-up or the design template, are sent to the Dentsply Implants production facility.

In order to improve the function and esthetics of bridge and hybrid restorations, the dental laboratory can take advantage of the option of the angulated screw access. This must be indicated in the order procedure.

Design

At the Dentsply Implants production facility, the master cast and the diagnostic tooth set-up are scanned in 3D and the suprastructure is designed. Prior to milling, the design is checked by the dental laboratory with the Atlantis Viewer and approved for production.

The completed suprastructure can be delivered with the corresponding Atlantis prosthetic screws. In the dental laboratory, the supra-structure is veneered with ceramic or composite and sent to the dentist with the screws.

Atlantis patient-specific implant suprastructures offer a unique feature – angulated screw access. By angling the screw channel, it is possible to optimally position the prosthetic screw access, and to improve the function and esthetics of the bridge and hybrid restorations.



An alternative procedure



One-stage/ Direct prosthetic procedure

Using the Hex Driver 0.9 mm, remove the MP Cover Screws from the MP Abutments. Ensure a tight fit of the MP Insert Screws or, for angled MP Abutments, the Insert Screw, using a Hex Driver 1.22 mm at a torque of 24 Ncm.

Two-stage/ Indirect prosthetic procedure

Unscrew the gingiva-forming components using the Hex Driver 0.9 mm, or expose the implants and remove the Implant Cover Screws.

Then, place the MP Abutments and tighten them with the corresponding MP Insert Screws, using the Seating Instrument for the MP Insert Screw. The recommended torque for the MP Insert Screws is 24 Ncm.

Placing the suprastructure

Clean and disinfect all components. Screw the veneered Atlantis Bridge or Hybrid onto the MP Abutments and seal the screw accesses.

Note: For the manufacturing of full-arch bridge constructions, the same procedure is used as for larger gaps.

The WeldOne concept

With the WeldOne Welding Unit and special welding components, a titanium wire is permanently connected to the abutments with exactly the correct force to achieve an optimum weld.

An electric current leads to fusion of the titanium material at the contact points between the titanium wire and the abutment in milliseconds.



Above: An intraorally welded titanium framework
Below: Completed restoration

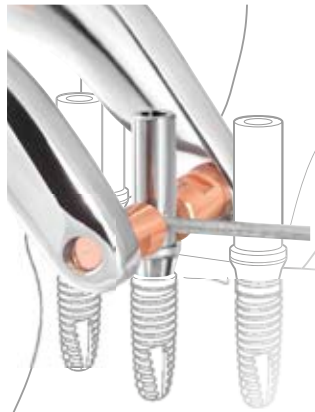

Different fabrication procedures can be selected for this unique concept for prosthetic restorations:

- Temporary restorations on implant level
- Temporary or durable restorations on abutment level

The WeldOne concept provides a stable, passively fitting framework for temporary or durable prostheses for immediate restorations on the same day of surgery.

It is a fast and economical solution to deliver partial- and full-arch restorations – suitable for immediate or late loading.

The WeldOne concept meets the patients' demand for immediate restorations – surgical procedure and prosthetic delivery on the same day of surgery:

Significant time and cost reduction due to standardized protocol with specially designed components for a reduction of appointments to a minimum and the opportunity to reduce total treatment costs.

Fewer risks of fractures on temporaries due to immediate reinforcement of the temporary by a titanium framework.

Safe and predictable for immediate loading treatment as immediate rigid splinting reduces mobility of the implants and thus minimizes the risk of implant failures during the healing phase.

No additional impression taking of implants necessary thanks to simultaneous delivery of a titanium framework on implant abutments at one time. Advantage of the “one abutment one time” philosophy in case of abutment level restorations.

The permanent joint between the titanium wire and the abutment enables an immediate and stable titanium framework to be made which will provide the optimum support for temporary or durable restorations.



Immediate reinforcement of the temporary by a titanium framework.



Xive Temporary Welding Abutments with Screws for EstheticBase; Xive MP Welding Sleeves with Abutment Screws for Welding Sleeve and Friadent Titanium Wires

The WeldOne Welding Unit

The WeldOne Unit is an electric resistance-pressure spot welding unit, specially created with touch screen and easy menu guidance. The WeldOne Unit is designed for the intraoral and extraoral welding technique in dental implantology. The welding unit is intended for welding titanium wires to abutments or caps on Xive or Ankylos implants directly inside the oral cavity of the patient.

The Xive Temporary Welding Abutment

For fabrication of an intraorally or extraorally welded titanium framework for immediate temporary restorations on Xive Implants.

Xive MP Welding Sleeve

For fabrication of an intraorally or extraorally welded titanium framework for immediate and late restorations on MP abutments.

Titanium Wires

For fabrication of an intraorally or extraorally welded titanium framework for implant-supported prosthetic restorations. Three sizes of titanium wires are available to ensure the stability of the framework according to the intended application and respective indication.

- Ø 1.2 mm for additional retention
- Ø 1.5 mm for inter-implant distances of up to 8 mm
- Ø 2.0 mm for inter-implant distances of between 8 mm and 15 mm

Intraoral and extraoral welding may only be performed subject to relevant training in order to ensure that the treatment procedure runs smoothly.

Step-by-step: The WeldOne concept

The WeldOne concept is an advanced protocol addressed to surgeons and prosthodontists who already have experience with immediate loading treatment.

Special training courses tailored to meet the indication requirements and the experience level are highly recommended. The teamwork of the surgeon and the dental technician is key to success.



Implant placement

After inserting the Xive S Implants as parallel to one another as possible, remove the pre-mounted TempBase Abutments from the Implants with a Hex Driver 0.9 mm. Inter-implant distances should not exceed the limit of 15 mm.

Placement of dedicated welding abutments

Temporary restoration on implant level: Place the Xive Temporary Welding Abutments in the implants and screw hand-tight using the retaining screw supplied and the Hex Driver 1.22 mm. Check the fit of the welding abutments. Make sure that no soft tissue is wedged between abutment and implant.

Durable restoration on abutment level: The Xive MP Welding Sleeves are selected corresponding to the diameters of the MP Abutments. Insert the MP Abutments in the implants and tighten at a torque of 24 Ncm. Place the Xive MP Welding Sleeves onto the MP Abutments and screw hand-tight with the Xive MP Retaining Screw for Welding Sleeve using the Ratchet Hex Driver 1.22 mm.

Bending, alignment and welding

Select the titanium wire according to the intended application and respective indication. Bend the titanium wire using standard dental bending instruments.*

After bending, shorten the titanium wire for intraoral or extraoral welding accordingly and place it on the Xive MP Welding Sleeves. Confirm the wire is free of tension and gaps. Align the titanium wire in a vestibular-oral direction and adjust to the prosthetic conditions. Position the two electrodes of the welding unit's welding clamp centrally on the titanium wire and the Xive MP Welding Sleeve. The clamping force of the welding clamp secures the components in position. Then, carry out the welding procedure.

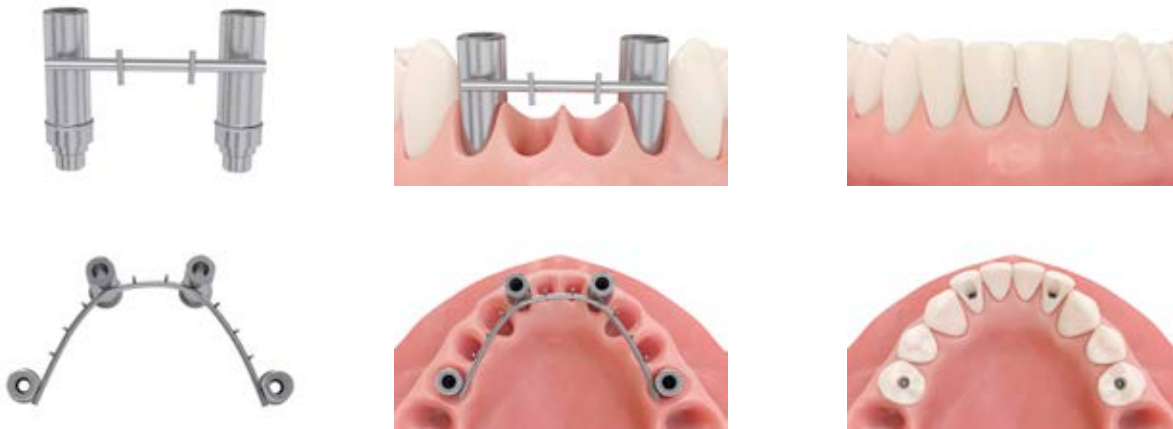

Additional retention elements

Release the retaining screws and remove the framework from the implants or MP abutments using the Ratchet Hex Driver 1.22 mm.

Additional retention elements can be added extraorally with the use of \varnothing 1.2 mm titanium wires.

Note: It is imperative to follow the welding parameter settings according to the table in the instructions for use and in the user manual.

* As an alternative, special custom-built tools can be ordered from Ustomed (www.ustomed.de).

Finalized titanium framework

The welding abutments and sleeves can be shortened occlusally. If, in such cases, the Xive MP Retaining Screw for Welding Sleeve is too long, the short Friadent MP Screw for castable sleeve can be used.

Check the manufactured titanium framework in the patient's mouth again to make sure that it is free of tension (e.g., Sheffield Test) before incorporating it into a plastic prosthesis.

Place the finished and opaqued coated titanium framework in the patient's mouth and screw hand-tight with the retaining screw provided in the implants or on the MP Abutments.

Completed restoration

Fill the ready-made plastic prosthesis with cold- or light-curing resin and place it on the framework. After the plastic has set, undo the retaining screw and prepare the plastic prosthesis according to the generally accepted dental regulations.

Place the prosthetic restoration in the implants or on MP abutments. Make sure that the abutments or sleeves are correctly seated and that no soft tissue is wedged between the abutment and implant. Check the passive fit of the prosthetic restoration, tighten the prosthetic screws using the Ratchet Hex Driver 1.22 mm at a torque of 24 Ncm. Then, check the occlusion.

Removable solutions for the edentulous jaw

The Locator concept



Restorations with Xive Locator

The self-aligning Locator makes correct placement of overdentures in both the maxilla and mandible easy and enables the compensation of axial divergences up to 40°.

Its low vertical height makes it an ideal solution, even for patients with restricted mobility or limited occlusal space.

Restorations with Friadent Ball and Socket Attachment

The adjustable Friadent Ball and Socket Attachment offers the option of quick and economical retention of overdentures in the mandible. Implant axial divergences of up to 15° can be compensated by rotating the socket on the ball.

The Friadent Ball and Socket Attachment concept allows for chairside processing, using the existing denture, as well as for the manufacturing of a new prosthesis in the dental laboratory.

Restorations with Friadent AuroBase

The AuroBase Abutment with its pre-fabricated implant connection serves as the basis for individual abutments enabling almost unlimited individuality.

It can therefore be used for restoring cases presenting special challenges such as large axial divergences or a limited inter-occlusal clearance with telescopic or conical crown technique.

Restorations with Friadent Telescopic Abutments

The Friadent Telescopic Abutment is used to secure overdentures on telescopic or conical crowns.

The Friadent Telescopic Abutment, made of titanium, allows customized preparation even in cases with axial divergences.

The SmartFix concept

The Atlantis Conus concept



Restorations with Xive/Friadent MP Abutments/Bars

Friadent Bar Copings are used to fabricate bar constructions to retain overdentures on Xive/Friadent MP Abutments. They are available in versions for soldering, laser-welding or casting.

Restorations with the Friadent MP Abutment/Atlantis Bar

With the Atlantis Bar on Friadent MP Abutments, the patient's final restoration is retained by attachments on a high quality and tension free patient specific bar.

Restorations with the Friadent MP Abutment/Atlantis 2in1 solution

Atlantis 2in1 provides primary and secondary suprastructures for a removable solution. The primary structure is fixed to implants while the secondary structure attaches to the primary using friction and additional retention elements. The secondary is a bridge or hybrid suprastructure finished with custom teeth and denture resin. The Atlantis 2in1 solution combines screw-retained stability with removable prosthetic convenience.

Restorations with the Atlantis Conus concept

The Atlantis Conus concept allows you to provide fully edentulous patients with a cost-effective, implant-supported prosthesis.

This solution has the stability of a friction-retained, non-resilient prosthesis, but the comfort of a fixed restoration.

The concept is composed of patient-specific Atlantis Conus Abutments together with pre-fabricated SynCone Caps.

The Locator[®] concept

The availability of a simple and secure fixation of an implant-supported prosthesis is a significant success factor for restorations in elderly patients.

The Xive Locator makes correct placement of overdentures in the maxilla and mandible much simpler, even for patients with limited mobility, with restricted occlusal volume or in cases with divergent implants.



Xive Locator Abutments and Locator Replacement Males (clear/strong, pink/light, blue/extra light. Extended range: gray/zero, green/strong, orange/light, red/extra light).

Due to the low overall height, the Locator Attachment System provides more room even in limited occlusal spaces:

- Low profile retention of the abutment
- Sufficient space for easy insertion of the prosthesis even with restricted interocclusal clearance

The self-aligning design allows fixation with one click:

- Easy alignment of the prosthesis
- Exact positioning by light pressure on the prosthesis

The options of flexible retention allow compensation of axial divergences.

- Retention can be customized using nylon color-coded inserts (replacement males) that offer a range of retentive forces
- Axial divergences up to 40° between two implants (20° each) can be compensated

Enduring durability of the prosthesis due to the secure retention.

- Double retention of the Locator abutment in comparison with conventional attachments for a significantly improved seating of the prosthesis
- Optimum prosthesis durability and significantly less wear with the nylon replacement male inserts

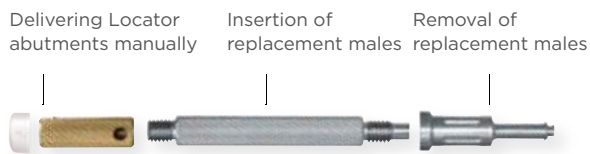

All treatment steps are conducted with the three-piece Locator Core Tool



Friadent Locator Insert for Prosthetic Ratchet

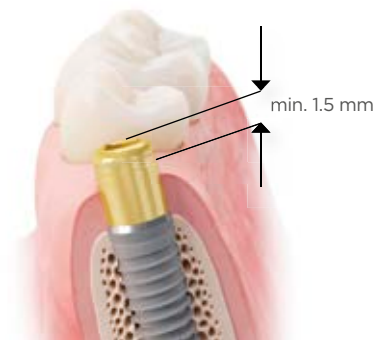

The functional area has to be located supragingivally.

Please read the instructions for use prior to using the Locator Implant Attachment System.

The Locator Implant Attachment System may only be used for its intended purpose according to the general rules for dental/surgical treatment, occupational safety and accident prevention.

To select the suitable Locator abutment, the implant diameter and the thickness of the gingiva must be known. The thickness of the gingiva determines the required gingival height of the abutment. The exact height of the abutment has been selected if the functional area is supragingivally located.

Note: Use the specified torque insert for final placement of the Locator abutment in the implant.

Step-by-step: The Locator[®] concept

The Locator concept allows for the fixation of an existing denture directly chairside. As an alternative, a new prosthesis can be manufactured in the dental laboratory.

The direct prosthetic procedure



The indirect prosthetic procedure

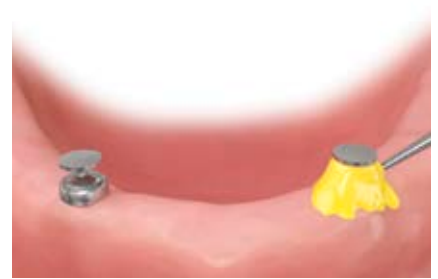

Placing the Locator Abutments

After removing the gingiva formers, select the Locator Abutments matching the gingival height. Screw in the abutments with the Locator Insert for Prosthetic Ratchet or the Locator Driver. For secure handling, slide the abutment holder sleeve onto the Locator Driver. The Locator Abutment will snap into the holder sleeve and will be retained in place. Tighten the Locator Abutments to 30 Ncm with the insert and the prosthetic ratchet.

Measuring the divergence

Position the black parallel posts on the abutments and measure the degree of divergence with the Locator Angle Measurement Guide. If the divergences are 10° or less per implant, the clear, pink or blue replacement male can be used depending on the amount of retention required. If the divergences are 10–20° per implant, use the replacement male in green, orange, red or grey.

Manufacturing a new prosthesis in the laboratory

If the prosthesis is manufactured in the laboratory, an impression of the clinical situation has to be made after delivery of the Locator Abutments.

Position the Locator Impression Copings with an integrated black replacement male on the Locator Abutments, and make an impression of the complete jaw.

The impression with the black replacement males remaining in the impression copings is then given to the laboratory. The dental laboratory manufactures the prosthesis measuring the divergence on the cast.

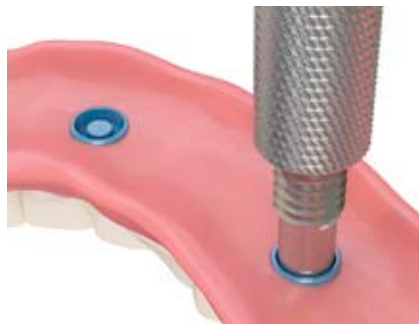

Preparation of the prosthesis

Position the white block-out spacers and females with an integrated black processing insert on the heads of the Locator Abutments. Make sure to have a gap-free fit and add block-out spacers if necessary. Position and fix the grinded prosthesis with polymer or cold-set polymer until the polymer is set. Please consider the directions of the polymer manufacturer.

Remove the prosthesis and processing replacement males and smooth out all sharp edges.

Delivery of replacement males

Firmly press the color-coded replacement males, selected for their divergence and desired retention force, into the females with the specified part of the Locator Core Tool. The replacement male must be flush with the margin of the female.

Delivery of prosthesis

Check the retention and insert the prosthesis.

Friadent® Ball and Socket Attachment

The adjustable Friadent Ball and Socket Attachment offers the option of quick and economical retention of overdentures. Implant axial divergences of up to 15° can be compensated by rotating the matrix (socket) on the ball-headed part of the male section (Attachment Screw).

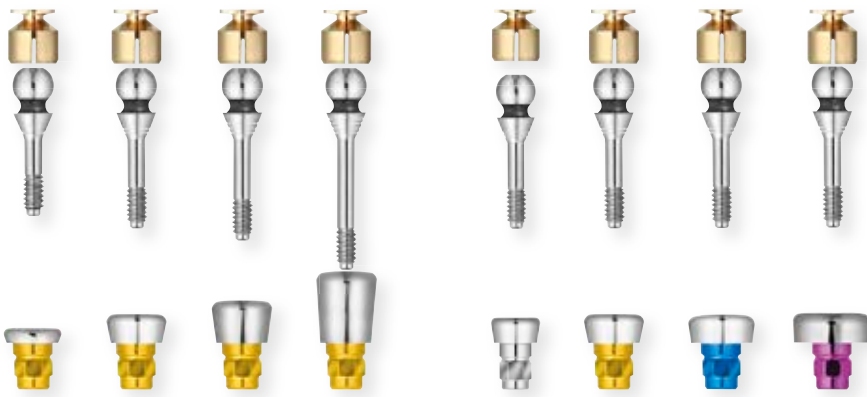

Friadent Ball and Socket Attachment
D 3.8, GH 1-5

Friadent Ball and Socket Attachment
GH 2, D 3.4-5.5



Friadent Activator/Deactivator
for Ball and Socket Attachment

Friadent Ball and Socket Attachment

The male section of the Friadent Ball and Socket Attachment consists of the Attachment Insert and the ball-headed Attachment Screw made from pure titanium. It is available in gingival heights of 1, 2, 3 and 5 mm.

The Attachment Insert has the color-coded implant-abutment connection and flares slightly from the implant diameter with rounded edges.

The adjustable Attachment Matrix is fabricated from high gold content precious metal alloy.

The rounded shape makes the Attachment easy to clean and thus particularly suitable for patients with limited manual dexterity.

Friadent Activator and Deactivator for Ball and Socket Attachment

The Deactivator has a conical working tip, which expands the lamellae of the Attachment Matrix.

The Activator compresses the lamellae of the Attachment Matrix, thus increasing the retention.

Friadent® Telescopic Abutment

The Friadent Telescopic Abutment is used to secure overdentures on telescopic or conical crowns. The direct processing of the Friadent Telescopic Abutment allows for fabrication of primary parts without casting.



Friadent Telescopic Abutment
D 3.0-5.5

Friadent Telescopic Abutment

The Friadent Telescopic Abutment forms the primary part for the simple and economic fabrication of telescopic or conical crowns for fixing prostheses and removable bridges as well as for customized single tooth crowns.

For manufacturing screw-retained single crowns, the Telescopic Abutment, except D 3.0 and D 3.4, can be veneered with titanium ceramics (e.g., Duceratin, Ducera or Vita Titan-keramik, Vita Zahnfabrik).

Note: The Friadent Telescopic Abutment D 3.0 can be used for direct acrylic veneering only.

The reverse conical shape allows for customized preparation and compensation of axial divergences with milling technique.

Step-by-step: Friadent® Ball and Socket Attachment

The Friadent Ball and Socket Attachment concept allows for fixation of an existing denture directly chairside. As an alternative, a new prosthesis can be manufactured in the dental laboratory.

The indirect prosthetic procedure



Dental Laboratory

After impression taking and completion of the master cast, the dental laboratory places the corresponding Attachment Inserts with the Friadent Seating Instrument for Attachment Insert and MP Insert and tightens them with the Attachment Screws. The Attachment Matrices are to be polymerized into the denture.

The direct prosthetic procedure

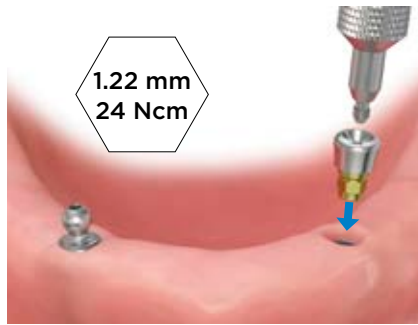

Placing the Attachment Inserts

After the peri-implant soft tissue has healed, place the Attachment Inserts with Friadent Seating Instrument for Attachment Insert and MP Insert. The gingival height of the inserts must be selected corresponding to the soft tissue height.

Use the Hex Screwdriver 1.22 mm to tighten the Attachment Screw with the recommended torque of 24 Ncm. The insert and screw form the male part of the Ball and Socket Attachment.



Alignment of the matrices

Place black silicone rings around the ball necks and align the matrices towards the pulling direction. This stabilizes the matrices and prevents ingress of auto-polymerizate into the region below. Axial divergences of the implants of up to 15° can be compensated with the alignment of the matrices.

Place white silicone rings on the lamellae of the matrices as spacers in order to prevent ingress of plastic and at the same time to create space to be able to adjust the matrices to the desired pull-off force if necessary.



Polymerization of the matrices

Perforate the denture in the areas of the implants and place it in the patient's mouth. Fix the retentive part of the matrix through the perforation with auto-polymerize.

After curing the plastic material, remove the blue silicone ring and smooth the intersections in the denture.

Adjustment of the friction

Adjust the friction with the Activator to increase friction or the Deactivator to decrease it. Redo adjustments after the wearing period.

Delivery of prosthesis

Check the fit of the prosthesis.

The same procedure is used for the manufacturing of constructions on Xive TG Implants. Please use the respective Xive TG components.

Step-by-step: Friadent® Telescopic Abutment

The Friadent Telescopic Abutment is used to secure overdentures on telescopic or conical crowns. After taking impressions in the practice, the prosthetic restoration is manufactured in the dental laboratory.

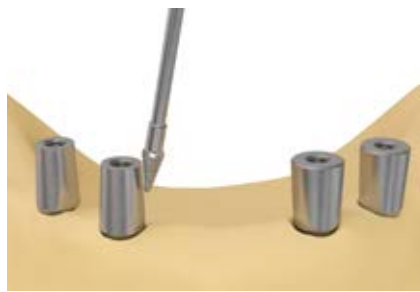
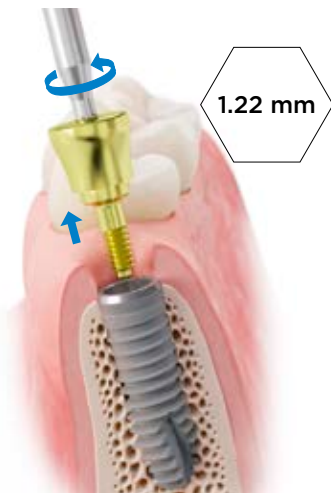

Impression taking

Expose the implants in case of submerged healing. Remove Cover Screw using the Hex Driver 0.9 mm or gingiva-forming components using the Hex Driver 1.22 mm and take impression as described starting on page 36. Mount/remount Gingiva Formers after taking the impression.

The laboratory receives the impression for casting the model.

The dental laboratory procedure

After casting the model with milling implants incorporated, the dental technician selects the corresponding Telescopic Abutments. Then, conical or telescopic crowns are milled directly from the pre-fabricated telescopic abutments in the milling machine. By doing so, a common slide-in direction for the future prosthesis is achieved.

Fabrication of the final denture

The secondary parts are modeled, cast and polymerized into the denture. The master cast with the Telescopic Abutments, abutment screws and the finalized denture are given to the dental practice for delivery.

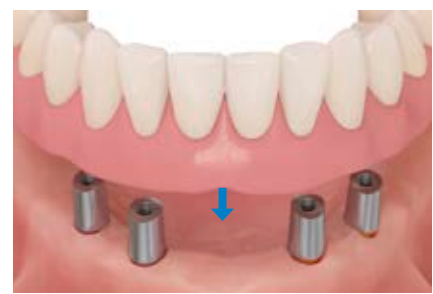
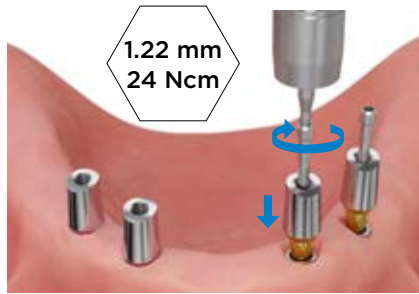
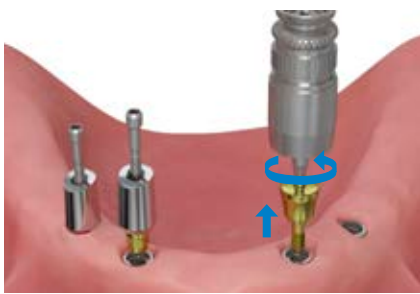

Removing the Xive Gingiva Formers C

Unscrew the Gingiva Formers using the Hex Driver 1.22 mm.

Place the customized Friadent Telescopic Abutments in the same implants and indexed position as determined in the model.

Placing the Friadent Telescopic Abutments

The Friadent Telescopic Abutments are to tighten with the abutment screws at 24 Ncm using the prosthetic ratchet and the Friadent Ratchet Hex Driver 1.22 mm or a torque-controlled contra-angle handpiece with the respective driver insert.

Delivery of prosthesis

Check the fit of the prosthesis.

Friadent® MP bar solutions: bar copings and assemblies

Friadent Bar Copings are used to fabricate bar constructions to retain overdentures on Friadent MP Abutments. They are available in versions for soldering, laser-welding and casting.



Friadent Bar Copings Gold/Titanium/Castable with
Friadent MP Coping Screws



Friadent Gold Bar Copings
D 3.4, D 3.8, D 4.5 and D 5.5

Friadent Bar Copings

The following pre-fabricated components are available for the fabrication of bar constructions:

- Gold Bar Copings, made from high gold content precious metal for the soldering technique
- Titanium Bar Copings for laser-welding
- Castable Bar Copings



Friadent Gold Bar round, Titanium Bar round Friadent Bar Clip Activator and Gold Bar Clip

Friadent Gold and Titanium Bars round

Pre-fabricated Friadent Round Bars of high gold content precious metal alloy or titanium are available in 50 mm lengths and 2 mm round cross-section. They are used to connect the bar copings in bar framework.

Friadent Bar Clip

The adjustable Friadent Bar Clips, fabricated of high gold content precious metal alloy are polymerized into the denture base for securely retaining it on the bar.

Friadent Bar Clip Activator

The Bar Clip Activator consists of three key-shaped instruments with blades in various widths (3, 10 and 15 mm) which are related to the length of the clip.

The Friadent Bar Clip Activator is used to adjust the friction to the patient's needs.

Step-by-step: MP Abutments with Friadent® Bar Copings

The prosthetic portfolio for Xive implants provides various options for the fixation of overdentures on bar constructions. All bar-supported overdentures are fabricated on MP Abutments or, as an alternative, on transgingival Xive TG Implants.

The prosthetic procedure on MP Abutments can follow both one- and two-stage protocols. The instructions below show the two-stage/indirect prosthetic procedure. For the one-stage/direct prosthetic procedure, see pages 104-105.

MP Abutments: the two-stage (indirect) procedure

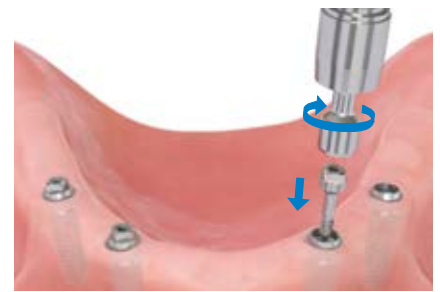
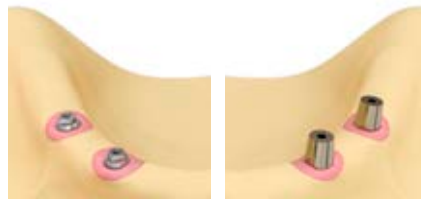
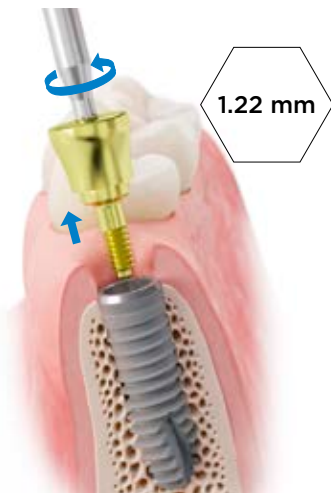

Impression taking and the dental laboratory procedure

Expose the implants in case of submerged healing. Remove the Cover Screw using the Hex Driver 0.9 mm or gingiva-forming components with a Hex Driver 1.22 and take impressions as described starting on page 36.

Mount/remount the gingiva formers after impression-taking. The laboratory receives the impression for casting the model.

The dental laboratory procedure

In the dental laboratory, MP Abutments are used according to diameter and gingiva height. The bar copings are screwed in with the MP Abutments.

The round bar segments are shortened to the required length, fixed with wax or plastic and soldered or lasered to the copings.

Placing the MP Abutments

Use the Hex Driver 1.22 mm to unscrew the Gingiva Former.

Then, place the corresponding MP Abutments and tighten with an MP Insert Screw, using the Seating Instrument for MP Insert Screw. The recommended torque for the MP Insert Screw is 24 Ncm.

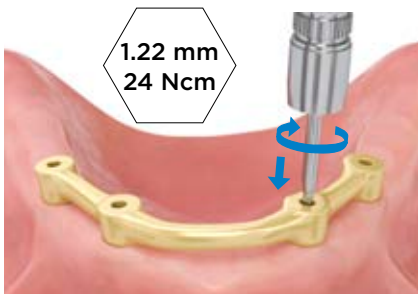

Placing the bar

Use the Friadent Hex Driver 1.22 mm or the Friadent Slot Screwdriver 2.0 mm to place the bar and tighten with the Friadent MP Coping Screw at a torque of 24 Ncm.

Adjusting the friction

According to the bar construction, the bar attachments have been poly-merized into the existing denture. Use the Friadent Bar Clip Activator to adjust the friction to the patient's needs.

Delivery of final prosthesis

Deliver the prosthesis on the bar and check friction.

The same procedure is used for the manufacturing of constructions on Xive TG Implants. Please use the respective Xive TG components.

Step-by-step: MP Abutments with the Atlantis® Bar

With an Atlantis Bar on MP Abutments, a high-quality and tension-free, patient-specific final restoration can be manufactured for supporting overdentures.

The prosthetic procedure on MP Abutments can follow either the one- or two-stage protocol. The instructions below show the one-stage/direct prosthetic procedure; for the two-stage/indirect prosthetic procedure, see pages 102-103.

MP Abutments: the one-stage (direct) procedure

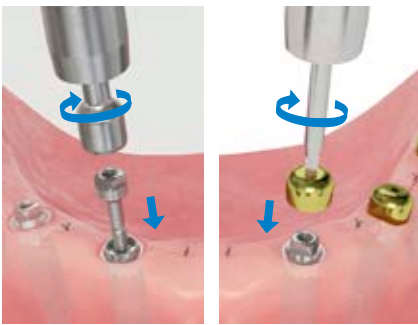

Placing and sealing the MP Abutments

Impressions can be taken either on the implant level (MP Abutments are selected by the dental laboratory) or on the abutment level (the model is cast on MP Analogs), using the respective impression copings (see p. 41 for the step-by-step instructions for impression taking).

At the dental laboratory, a soft-tissue mask and a silicone key are used to make a diagnostic tooth set-up or a design template made of wax or plastic on the master model for the manufacture of the bridge or hybrid construction.

The dental laboratory procedure

Framework orders are submitted through Atlantis WebOrder (www.Atlantisweborder.com). The master cast and, if applicable, the MP analogs or MP abutments and the diagnostic tooth set-up, or the design template, are sent to the Dentsply Implants production facility.

In order to improve the function and esthetics of bridge and hybrid restorations, the dental laboratory can take advantage of the option of the angulated screw access. This must be indicated in the order procedure.

Design

At the Dentsply Implants production facility, the master cast and the diagnostic tooth set-up are scanned in 3D, and the suprastructure is designed. Prior to milling, the design is checked by the dental laboratory with the Atlantis Viewer and approved for production.

The completed suprastructure can be delivered with the corresponding Atlantis prosthetic screws. In the dental laboratory, the supra-structure is veneered with ceramic or composite and sent to the dentist with the screws.



An alternative solution

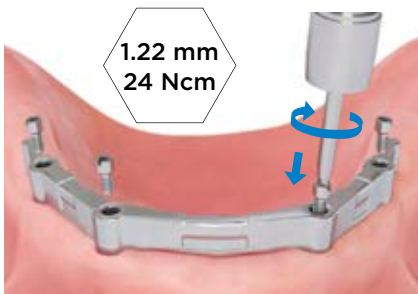

Placing the bar

Using the Hex Driver 0.9 mm, remove the MP Cover Screws from the MP Abutments. Ensure a tight fit of the MP Insert Screws or, for angled MP Abutments, the Insert Head, by using a Hex Driver 1.22 mm at a torque of 24 Ncm.

Delivery of prosthesis

Place the final prosthesis.

The same procedure (Atlantis Bar, as well as Atlantis 2in1 Solution) is used for the manufacturing of constructions on Xive TG Implants. Please use the respective Xive TG components.

Atlantis 2in1 solution

The primary structure of the Atlantis 2in1 is screw-retained on the MP Abutments. The secondary structure is a bridge or hybrid suprastructure with an incorporated CAD/CAM-fabricated framework, finished in the dental laboratory with custom teeth and denture resin. At final delivery to the patient, the secondary structure is attached to the primary structure using friction and additional retention elements.

Step-by-step: The Atlantis® Conus concept

The Atlantis Conus concept is a conometric solution for patient-specific, non-resilient yet removable prostheses that provide patients with the stability and comfort of a fixed palate restoration with the ease of maintenance of a removable denture.

An all-acrylic existing or new full denture should be used as a temporary prosthesis. The example below shows the procedure for a temporary solution, based on the patient's existing denture, requiring no new supporting framework. After three to six months, the prosthesis should be supported by a metal framework.

All-acrylic prosthesis

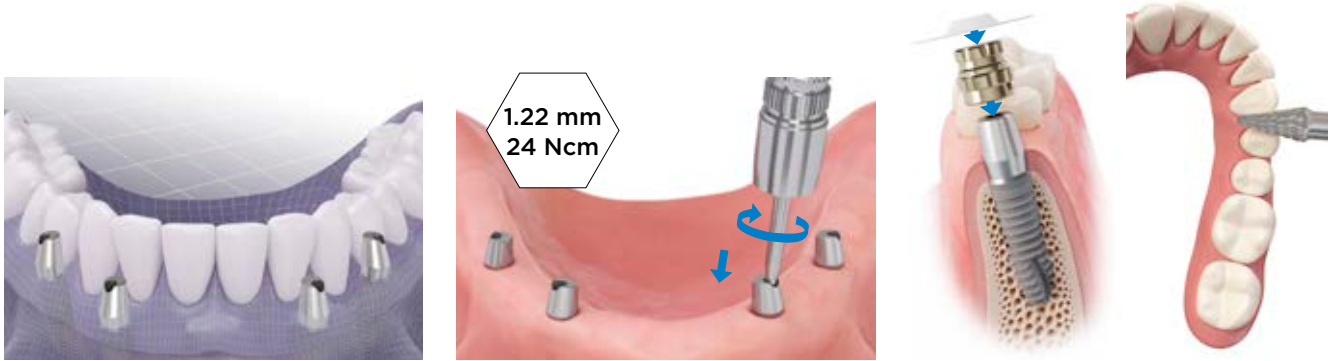

The dental laboratory procedure and design

Models and tooth set-up are scanned and the Atlantis Conus Abutments are ordered by the dental laboratory in Atlantis WebOrder.

Upon approval of the abutments design (if requested), the Atlantis Conus Abutments are manufactured, inspected and shipped to the customer.

Placing the Conus Abutments

After healing, install the Atlantis Conus Abutments, preferably using an insertion guide. Conus Abutments are to tighten with the abutment screws at 24 Ncm using the prosthetic ratchet and the Friident Ratchet Hex Driver 1.22 mm or a torque-controlled contra-angle handpiece with the respective driver insert.

Seal the screw access holes with composite.

Placing the Caps and preparation of the prosthesis

Place the Caps on the abutments by applying firm pressure. Then, place the silicone sleeves to masque the undercuts. The sleeves help to prevent any cold-set polymer from penetrating the sulcus region between the Cap and the abutment. Alternatively, a cofferdam can be used in the same manner.

The prosthesis must match the mucosa and meet functional and esthetic requirements. Relieve the prosthesis sufficiently to create the space needed for the Caps. Extended functional margins should be shortened as far as possible.



Atlantis Conus Abutments



Pre-fabricated Caps with retention (for acrylic temporary prosthesis) and without retention (for precise seating into a framework)

Metal-framework prosthesis

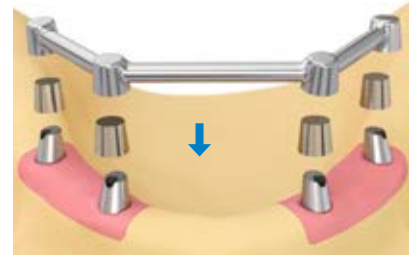

Polymerization of the SynCone Caps

Fixation and pick-up of the SynCone Cap can be accomplished by one of the two following methods:

- The direct method is accomplished by adding autopolymerizing resin or a light-set material to the coping through the prepared window.
- The indirect method is accomplished by picking up the Cap in a reline impression for processing in the dental laboratory.

Delivery of the prosthesis

Insert the finished prosthesis and check the retention, stability and occlusion. The internal surface of the prosthesis should be evaluated to ensure that it is implant-supported only, with no points of pressure on the soft tissue.

Final prosthesis

The final prosthesis includes a supporting framework and vestibular extensions to accommodate the specific needs of the patient.

Note: Bonding of the framework to the Cap should be performed intraorally and not in the dental laboratory.

For detailed information, please refer to the Atlantis Conus concept manual.

Xive® TG prosthetics

The basics of Xive® TG prosthetics

If function is the first priority, the single-component transgingival Xive TG implant is a simple and straightforward alternative. The complete range of prosthetic concepts can be implemented with abutments for single-tooth restorations, bridges and overdentures: a second surgical procedure is not necessary, the treatment is completed faster, and efficiency is maximized.

Xive TG implants of all diameters are restored with components of one prosthetic diameter (D 3.8).

Xive TG is fully compatible with the prosthetic components for Xive S because the abutment interface matches the Friadent MP D 3.8.

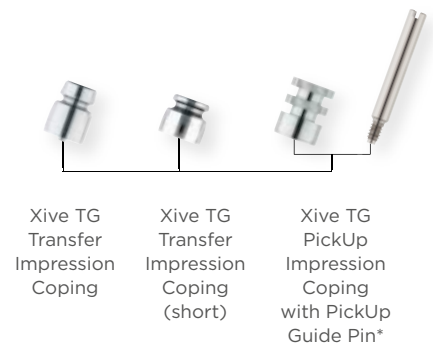

* In order to transfer the double square positioning geometry of Xive TG prosthetic components, impressions for single tooth restorations on Xive TG have to be taken using the Xive TG PickUp Impression Coping.

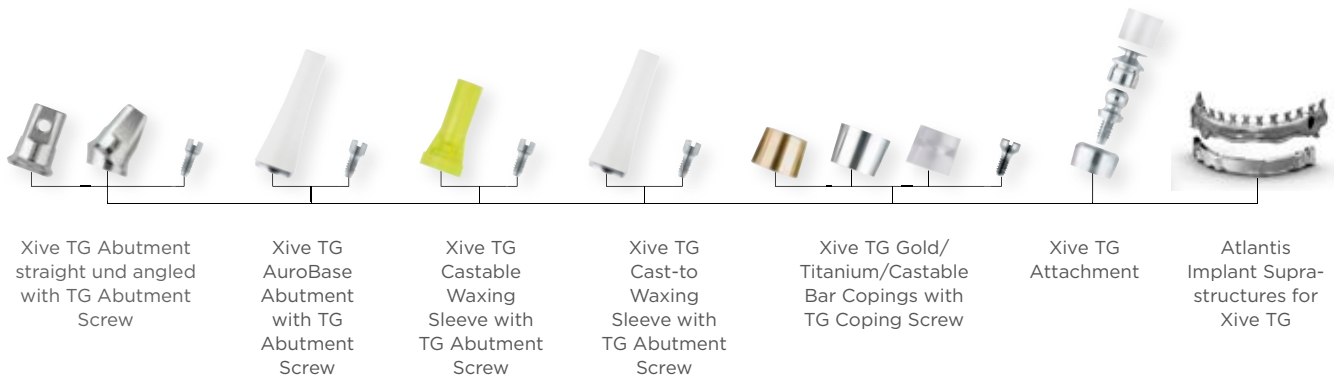

Simplified procedures - less trauma

The use of a transgingival implant not only means accelerated implant treatment but also simplified placement of the prosthetic restoration. Working at gingival level simplifies the prosthetic procedures and minimizes trauma to the soft tissue. Xive TG is the right implant for every case with a transgingival indication.

Xive® TG prosthetic navigator

Fixed Solutions

Single crowns and bridges

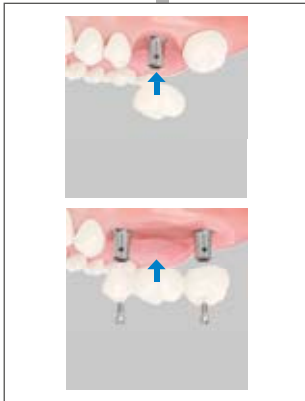

The Xive TG Abutment

Titanium Xive TG Abutments, straight and angled, are used to fabricate horizontally screw-retained or cemented single tooth crowns and bridges.

All Xive TG Abutments are provided with a horizontal thread. An additional horizontal or transverse screw is necessary for screw-retained crowns.

For instructions, see page 112.

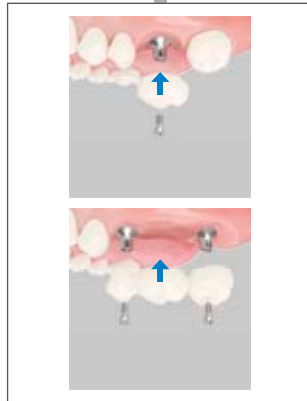

The Xive TG AuroBase Abutment

The Xive TG AuroBase abutment acts as the base for the fabrication of custom abutments for bridges. The restorations can be cemented or horizontally screw-retained.

The cast-to implant interface provides a machined fit with unlimited versatility in fabricating the abutment, making it particularly suited for compensating severe axial divergences.

For instructions, please see the same procedure with Friadent AuroBase, page 58.

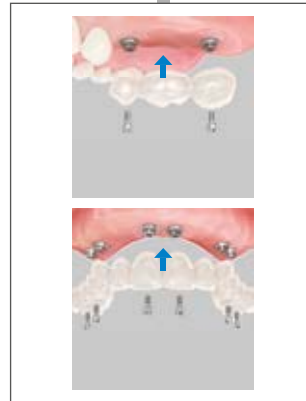

The Xive TG Bridge

Xive TG castable or cast-to waxing sleeves are used as a base for the fabrication of screw-retained bridges.

For instructions, see page 114.

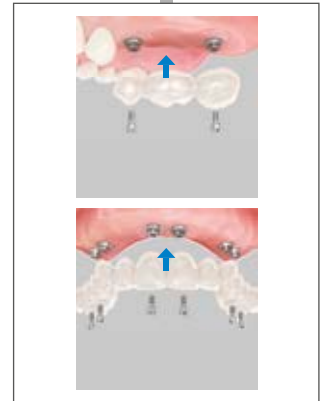

The Xive TG Atlantis Bridge/Hybrid

With an Atlantis bridge or hybrid restoration on transgingival Xive TG implants, restorations for partially or fully edentulous patients can be fabricated.

Individually milled, fixed, high quality Atlantis bridges and hybrids are tension-free and allow for larger spans without segmentation.

For instructions, see page 116.

Removable Solutions

Overdentures



The Xive TG Attachment

Xive TG Attachments, consisting of a two-piece attachment matrix and an attachment matrix, are used for fixing overdentures in the mandible. The protocol, with an option for chairside restorations, is simple. Axial divergences can be compensated.

The same procedure is used for the manufacturing of constructions with a Ball and Socket Attachment. **For instructions, see page 94.**



The Xive TG Bar/Atlantis Bar

Xive TG bar copings are used for the fabrication of bar constructions for bar-supported prostheses. They are available as pre-fabricated components for both soldering and laser welding.

With an Atlantis bar on Xive TG, the patient is restored with a patient-specific CAD/CAM-fabricated bar structure for a final restoration of high quality and passive fit.

The same procedure is used for the manufacturing of constructions on Xive MP Abutments. **For instructions, see page 102.**



The Xive TG Atlantis 2in1 Solution

Atlantis 2in1 provides primary and secondary suprastructures for removable solutions. The primary structure is fixed to implants while the secondary structure attaches to the primary using friction and additional retention elements. The secondary is a bridge or hybrid suprastructure finished with custom teeth and denture resin. The Atlantis 2in1 solution combines screw-retained stability with removable prosthetic convenience.

The same procedure is used for the manufacturing of constructions on Xive MP Abutments. **For instructions, see page 103.**

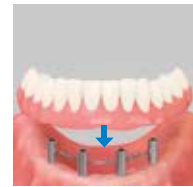

The WeldOne Concept for Xive TG

The WeldOne concept provides a stable, passive fit framework for temporary or durable prostheses for immediate restorations on the same day of surgery.

For instructions, see page 84.

Impression taking with Xive® TG

Xive TG significantly reduces the inventory as all implants utilize 3.8 mm diameter prosthetic components.

Due to the transgingival implant design, all impressions are made at the gingival level. The impression for the Xive TG implant can be made by the repositioning or the PickUp technique.

Same prosthetic diameter

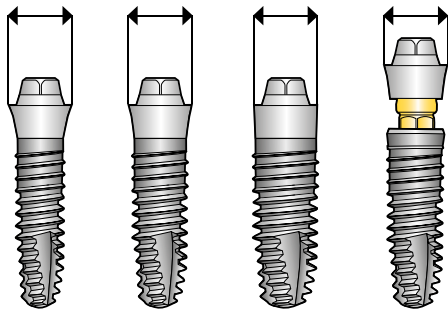

Xive TG D 3.4 Xive TG D 3.8 Xive TG D 4.5 Xive S D 3.8 plus MP abutment



Xive TG Transfer Impression Coping Xive TG Transfer Impression Coping (short) Xive TG PickUp Impression Coping with PickUp Guide Pin

The implant interface of all Xive TG Implants has the same prosthetic interface diameter, matching the diameter of the 3.8 Friadent MP Abutment. Therefore, the impression copings for D 3.8 are compatible with all Xive TG diameters.

If a transfer of the head square is not required, Friadent MP Transfer Impression Copings D 3.8 are used.

Xive TG Impression Copings

- For transferring the transgingival implant position to the master cast
- Available for PickUp (open tray) and transfer technique
- Transfer Impression Copings short for impression taking with an existing overdenture

In order to transfer the double square positioning geometry of Xive TG prosthetic components, impressions for single tooth restorations on Xive TG have to be taken using the Xive TG PickUp Impression Copings.

The repositioning technique (closed tray)



Use the Hex Driver 0.9 mm to remove the Xive TG Cover Screws. Screw the Xive TG Transfer Impression Copings onto the implants.

Apply impression material around the transfer copings. Place the tray, filled with impression material, and make the impression. After the impression material has set, remove the tray and reposition the transfer copings in the impression. For casting the model, the dental laboratory uses Xive TG Implant Analogs or Xive TG Soldering Analogs.

The Xive TG implants are sealed again with the Xive TG Cover Screws until the final restoration is delivered.

The repositioning technique (existing prosthesis)



Use the Hex Driver 0.9 mm to remove the Xive TG Cover Screws. Screw the Xive TG Transfer Impression Copings short onto the implants.

For impression taking use the existing prosthesis as an impression tray. After the impression material has set, remove the prosthesis and reposition the transfer copings in the impression. For casting the model, the dental laboratory uses Xive TG Implant Analogs or Xive TG Soldering Analogs.

The Xive TG implants are sealed with the Xive TG Cover Screws again until the final restoration is delivered.

The PickUp technique (open tray)



Use the Hex Driver 0.9 mm to remove the Xive TG Cover Screws. Position the Xive TG PickUp Impression Copings on the implants, and screw the Xive TG Guide Pins in with the Hex Driver 1.22 mm. Perforate the tray to accept the PickUp Guide Pins.

Apply impression material around the PickUp Impression Copings. Place the tray filled with impression material and make the impression. After the impression material has set, unscrew the TG PickUp Guide Pins to remove the tray. The PickUp Impression Copings will remain in the impression without repositioning.

The Xive TG implants are sealed with the Xive TG Cover Screws again until the final restoration is delivered.

Step-by-step: The Xive® TG Abutment

Titanium Xive TG abutments, straight and angled, are used to fabricate horizontally screw-retained or cemented restorations. The pre-fabricated, customizable abutments are available in one prosthetic diameter with its base matching all available Xive TG implant diameters.



Removing the Xive TG Cover Screw

Use the Hex Driver 0.9 mm to unscrew the Xive TG Cover Screw.

Placing the Xive TG Abutment

Place the Xive TG Abutment in the implant according to the index position determined on the model. Use the Hex Screwdriver 1.22 mm or a torque-controlled contra-angle handpiece to tighten the Xive TG Abutment Screw with the recommended torque of 24 Ncm.

Cementing the superstructure

Phosphate cements can be used for cementing. Doing so, take care to completely remove the excess cement at the crown margins. When cementing with temporary cement, the upper two-thirds of the abutment has to be roughened.



The abutments have a double internal square with a flat-to-flat width to prevent rotation. This design offers eight options to position the abutment.

An alternative procedure

An alternative procedure

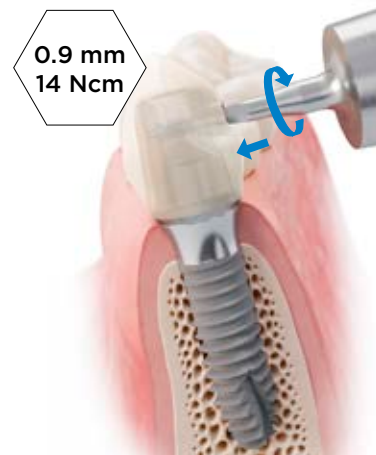
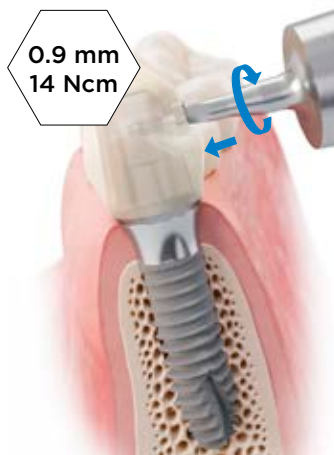

The dental laboratory procedure

The abutments can be customized in the laboratory. Do not allow the wall thickness to fall below 0.8 mm during preparation of the abutment.

Screwing in the superstructure horizontally

With horizontal screwing, secure the superstructure in the oral abutment wall. Depending on the clinical situation, horizontal screws with standard or long head lengths can be selected.

Tighten the horizontal screw using the Friadent Hex Driver 0.9 mm to the recommended torque of 14 Ncm.

Screwing in the superstructure transversally

With transversal screwing, secure the superstructure in both the oral and vestibular abutment wall. Transverse screws have double threading length to ensure optimal stability.

The use of the transversal screw with a long head is recommended for molars since the crown usually requires wider contouring. Tighten the transversal screw using the Friadent Hex Driver 0.9 mm to the recommended torque of 14 Ncm.

Step-by-step: The Xive® TG Bridge with Castable/Cast-to Waxing Sleeves



Impression taking

Take an abutment-level impression, (see pages 42 and 43 for step-by-step instructions on impression taking).

Dental laboratory

Reposition the Xive TG Transfer Impression Copings in the impression. The dental laboratory attaches Xive TG Implant Analogs or Xive TG Soldering Analogs to the impression copings for fabricating the master cast.

The Xive TG PickUp Impression Copings remain in the impression without repositioning.

Fabrication of the superstructure

The superstructure is fabricated in the dental laboratory using Castable or Cast-to-Waxing Sleeves.

The bridge construction is waxed-up, cast and, prior to delivery, polished with the intended finishers.

No finishers are required when using the Cast-to-Waxing Sleeve. Subsequently, the bridge is veneered.

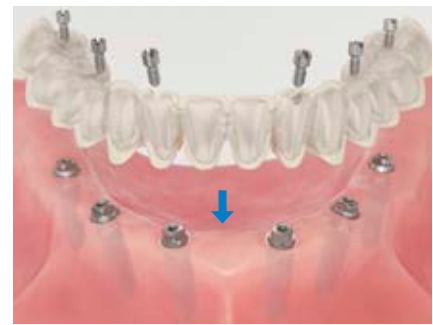
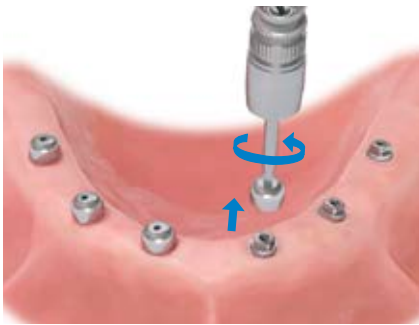

Removing the Xive TG Cover Screw

Remove the Xive TG Cover Screw using the Hex Driver 0.9 mm.

Checking the fit

Prior to the final completion, check the fit for correlation, esthetics, phonetics and bite conditions (Sheffield Test, see p. 47).

Placing the superstructure

Secure the superstructure with Xive TG Coping Screws, using the Friadent Hex Driver 1.22 mm or the Friadent Slot Screwdriver 2.0 mm with a torque of 24 Ncm.

Step-by-step: The Xive[®] TG Atlantis[®] Bridge and Hybrid

A patient-specific suprastructure on the Xive TG implant provides the advantages of a high precision, patient-specific restoration and the cost-effectiveness of a transgingival implant. Surgery performed in just one stage saves time and money and is comfortable for the patient.

Due to the transgingival design of the implant, additional abutments are no longer necessary. The prosthetic restoration for Xive TG allows you to choose between a patient-specific implant suprastructure for a fixed or a removable dental implant prosthesis.



Impression taking and the dental laboratory procedure

Take an abutment-level impression, (see pages 42 and 43 for step-by-step instructions on impression taking).

At the laboratory, a soft-tissue mask and a silicone key are used to make a diagnostic tooth set-up or a design template made of wax or plastic on the master cast. This model is used for the manufacture of the bridge or hybrid construction.

Order procedure

Orders are submitted through Atlantis WebOrder (www.Atlantisweborder.com). The master cast and the diagnostic tooth set-up or the design template are sent to Dentsply Implants.

In order to improve function and esthetics of bridge and hybrid restorations, the dental laboratory can take advantage of the option of the angulated screw access. This must be indicated in the order procedure.

Design

At Dentsply Implants, the master cast and the diagnostic tooth set-up are scanned and designed using the Atlantis 3D editor. Prior to milling, the design is checked by the laboratory with the Atlantis Viewer and approved for production.

The completed suprastructure can be delivered with the corresponding Atlantis prosthetic screws. In the dental laboratory, the supra-structure is veneered with ceramic or composite and sent to the dentist with the screws.

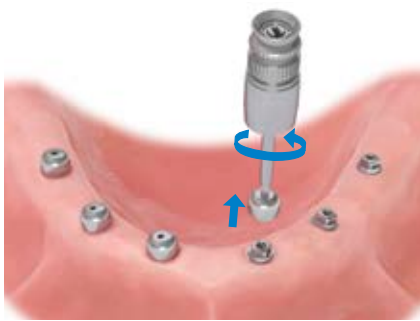

Removing the Xive TG Cover Screws

Remove the Xive TG Cover Screws using the Hex Driver 0.9 mm.

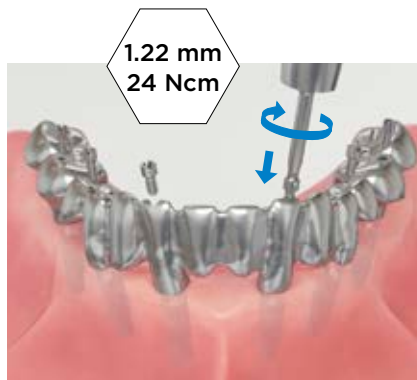

Placing the bridge/hybrid

The Xive TG Coping Screws are to tighten with the recommended torque of 24 Ncm using the prosthetic ratchet and the Friadent Ratchet Hex Driver 1.22 mm or a torque-controlled contra-angle handpiece with the respective driver insert.



Placing the suprastructure

Clean and disinfect all components. Screw the veneered Atlantis Bridge or Hybrid onto the Xive TG Implants and seal the screw accesses.

Notes

Notes

About Dentsply Sirona Implants

Dentsply Sirona Implants offers comprehensive solutions for all phases of implant therapy, including Ankylos®, Astra Tech Implant System® and Xive® implant lines, digital technologies, such as Atlantis® patient-specific solutions and Simplant® guided surgery, Symbios® regenerative solutions, and professional and business development programs, such as STEPPS™. Dentsply Sirona Implants creates value for dental professionals and allows for predictable and lasting implant treatment outcomes, resulting in enhanced quality of life for patients.

About Dentsply Sirona

Dentsply Sirona is the world's largest manufacturer of professional dental products and technologies, with a 130-year history of innovation and service to the dental industry and patients worldwide. Dentsply Sirona develops, manufactures, and markets a comprehensive solutions offering including dental and oral health products as well as other consumable medical devices under a strong portfolio of world class brands. As The Dental Solutions Company™, Dentsply Sirona's products provide innovative, high-quality and effective solutions to advance patient care and deliver better, safer and faster dentistry. Dentsply Sirona's global headquarters is located in York, Pennsylvania, and the international headquarters is based in Salzburg, Austria. The company's shares are listed in the United States on NASDAQ under the symbol XRAY.

Visit www.dentsplysirona.com for more information about Dentsply Sirona and its products.