



CEREC Primemill™ Station

Efficient Organization

THE DENTAL
SOLUTIONS
COMPANY™



The new CEREC Primemill™ Station is a great way to house your new CEREC Primemill™ with added storage!

The cabinet helps to eliminate clutter and provides fast and easy access to essential milling items.

The milling station is also great for noise reduction with its sound dampening lining and sealed gaps. While milling a new crown, close the cabinet lid and doors to reduce the noise.

To keep things clean and organized, the CEREC Primemill™ Station provides room for the self-contained vacuum to remove dust and debris.

The cabinet was designed to provide ventilation and prevent overheating for any integrated components.

CEREC Primemill™ Station features include:

- 1. Sound Dampening**
- 2. Block Storage (Drawer)**
- 3. Water Tank Storage (2)**
- 4. Vacuum Area**
- 5. Additional Storage**

Don't have the new CEREC Primemill™ yet? Don't worry. The new cabinet will also fit CEREC® MCX, CEREC® MC XL or the Inlab MC XL milling unit.

CEREC Primemill™ Station Tabletop
CEREC Primemill™ Station Base



Modular

The modular design of the new CEREC Primemill™ station allows you to mix and match different configurations to best suit the needs of your office environment.



CEREC Primemill™ Tabletop with CEREC Primemill™ Station Base and CEREC® Station Base with Doors



CEREC Primemill™ Station Tabletop

Additional Base Stations

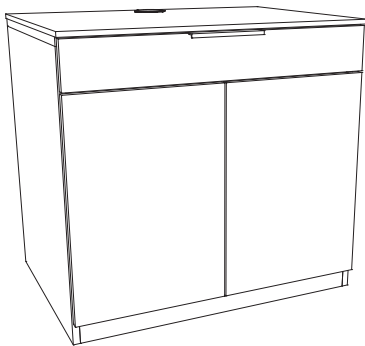

CEREC® Station Base with Doors

The CEREC® Station Storage Base with Doors is great for added storage for your Speedfire and other storage needs in your office.

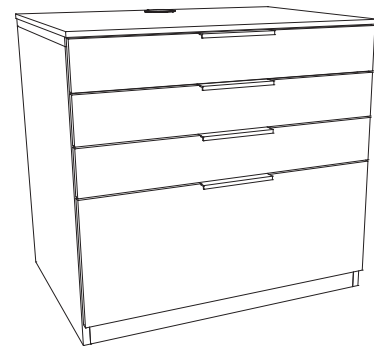

CEREC® Station Base with Drawers

The CEREC® Station Storage Base with Drawers base features 4 drawers for added storage of consumable materials, keeping you organized and efficient.

Details

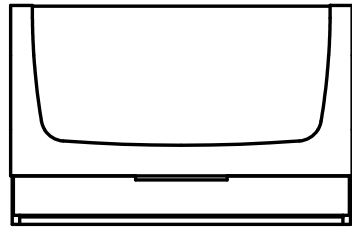
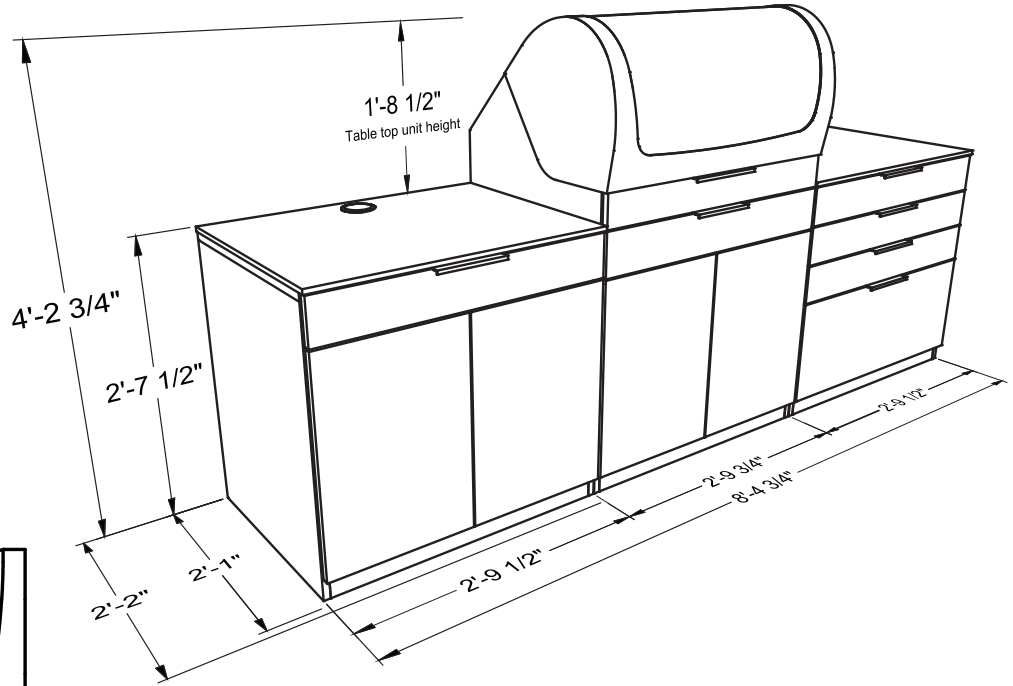

CEREC Primemill™ Station Tabletop
Part #: 100008549



CEREC® Station Countertop
Part #: 100008546

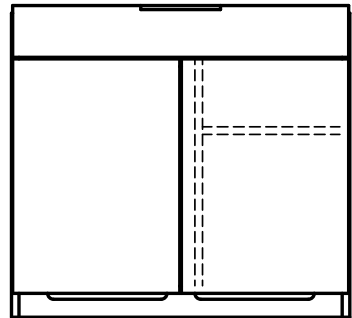

CEREC Primemill™ Station Base
Part #: 100008545

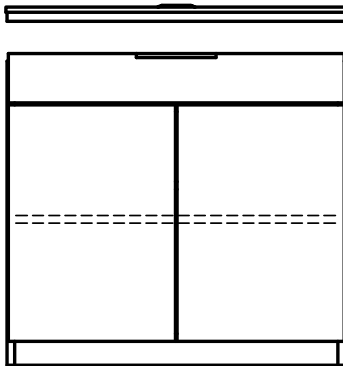

CEREC® Station Base with Doors
Part #: 100008547

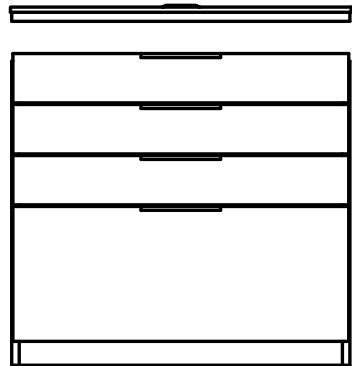

CEREC® Station Base with Drawers
Part #: 100008548

Wheel retrofit kit for all base cabinets
Caster Set - CEREC® Station Base
Part #: 100008550

For more information contact your Dentsply Sirona representative directly or call 844-848-0137